

PROFILSTÅLKATALOG ●●●●

2008



 **LOGOSOL**
Bäst på småskalig träförädling

Profilstålkatalog 2008



Vi kan presentera många nya profilstål i den här katalogen. Du kan räkna med omgående leverans av de stål som finns i katalogen.

Ett bra sortiment av stål är en viktig faktor för dig som vill tjäna pengar på

din hyvel. Möjligheten att leverera exakt den profil kunden vill ha är ofta nyckeln till de riktigt lönsamma affärerna.

Vi tar hela tiden fram nya standardstål. Du kan se dem på vår hemsida, www.logosol.se.

Jag önskar dig lycka till med arbetet med din hyvel vare sig det är hyvling för eget behov eller yrkesmässig verksamhet.

Du är alltid välkommen att kontakta oss om du vill ha rådgivning.

Med vänlig hälsning

Bengt-Olov Byström
VD, Logosol

Garanti

Du har 2 års garanti på samtliga maskiner från Logosol. Undantag från garantin är förslitningsdetaljer som remmar, svärd och kedjor. På begagnade maskiner lämnas ett års garanti.

Betalning

Normalt betalas alla varor kontant eller mot efterkrav. Efter överenskommelse så kan vi fakturera varorna på 15 dagar. Vill du dela upp betalningen så kan vi hjälpa dig med betalning genom Handelsbanken.

Leveranstid och transportsätt

Vanligtvis sker leverans omgående från lager men under högsäsong kan leveranstiden bli något längre. Vi har fasta fraktpriser och inga expeditionsavgifter.

Brev max. 2 kg (ej tjockare än 3 cm) 23:-

Postpaket, upp till 30 kg 48:-

Över 30 kg (och skrymmande gods) skickar vi med Bilspedition.

Prisexempel: (totalkostnad)

Solosåg 220:-, Elsåg 120:-, Solohyvel 220:-, Bandsåg 220:-, Panelhyvel 550:-

Transportskador

Om du vid mottagandet upptäcker att någon del av försändelsen saknas eller är transportskadad, ska du omedelbart anmäla detta till föraren. Kontakta oss om transportören inte åtager sig skadeansvaret.

Vi reserverar oss mot prisändringar.

Innehållsförteckning

Sida	Innehåll
4	Specielltillverkning av stål
5	Profilståltyper
5	Planhyvelstål
5	Profilstålpriser
5	Kuttrar och kilar

Kombinationer sid. 6-20

6	Regel & Trall
7	Not & spont
8	Lockpanel
8	Utomhuspaneler
9	Inomhuspaneler
11	Spårning & Urfräsning
11	Hörnkloss
11	Bröstlist
11	Dekorlist
12	Golvlist
13	Foder
14	Taklist
15	Falsstål
15	Kvartsstav
16	Pelare
16	Rundstav
16	Övriga
17	Stål till Solohyveln

Profilstål i HSS sid. 21-30

21	Profilstål i HSS 40 mm
25	Profilstål i HSS 50 mm
28	Profilstål i HSS 60 mm
28	Profilstål i HSS 80 mm
29	Profilstål i HSS 100 mm
30	Profilstål i HSS 130 mm

Fasta och ställbara fräsar sid. 31

31	Fasta och ställbara fräsar till Logosolhyvlar
----	---

Profilståltyper

■ Det förekommer 3 kvaliteter på dessa stål, VS (verktygsstål), HSS (snabbstål) och HM(Hårdmetall). En tumregel kan vara att om du ska fräsa mindre än 200 löpmeter virke så kan du använda VS. Ska du fräsa mer än 200 löpmeter, köra i ändträ eller mycket hårda träslag, bör du använda HSS-stål.

Hyvelstål HSS

Detta är det vanligast förekommande hyvelstålet som ger mycket bra resultat i massiva material.

Hyvelstål HM

Ett bra alternativ för den som hyvlar mycket i hårt slitande material, typ spånskiva, teak etc.

Hyvelstål VS

Stål lämpade för korta serier och experiment. Skärpan räcker till några hundra löpmeter, men priset är lågt.

■ Stål liknande dessa passar till våra sidokuttrar och andra kuttrar på marknaden med denna hålbild.

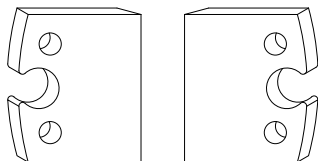

■ Dessa stål passar till TB98-kuttern samt i överkuttern på våra hyvlar.

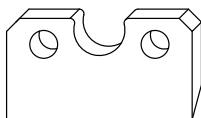

Planhyvelstål



Planhyvelstål HSS

Passar till:	Längd:	Art.nummer:	Pris:
SH230/Timmerfräs*	230	7000-002-8230	233 kr
PH260 under	300	7000-002-8300	285 kr
PH200	330	7000-002-8330	310 kr
PH260 över/DH410	410	7000-002-8410	340 kr

Planhyvelstål HM

Passar till:	Längd:	Art.nummer:	Pris:
SH230/Timmerfräs*	230	7000-003-8230	1600 kr
PH260 under	300	7000-003-8300	2060 kr
PH200	330	7000-003-8330	2180 kr
PH260 över/DH410	410	7000-003-8410	2280 kr

* Om planstål ska monteras i Timmerfräsen krävs långa kilar för montering. Kontakta oss för mer information.

Profilstålspriser

Stål av samma bredd och kvalitet har samma pris. Oavsett om det är sido- eller horisontalkutter.

Stålbredd:	Kvalité:	Pris/par:
40 mm	VS	143 kr
50 mm	VS	236 kr
40 mm	HSS	358 kr
50 mm	HSS	461 kr
60 mm	HSS	528 kr
80 mm	HSS	630 kr
100 mm	HSS	777 kr
130 mm	HSS	880 kr

Specialstålspriser

Specialstål kan tillverkas efter dina egna önskemål. Kontakta Logosol för pris.

Kuttrar och kilar

Kutter TB90 2-/ 4-skär

Två kuttrar kan ställas på varandra. Kilar och planstål ingår. Finns även med fyra skär för ännu bättre yta eller högre matningshastighet.



Art.nummer:	Pris:
7000-000-9092	925 kr
7000-000-9094	1500 kr

Ställbara kutterkilar

För infästning av profilstål i horisontella Logosolkuttrar.



Art.nummer	Pris/par:
7000-000-9506	355 kr

Kutterkilar

För infästning av profilstål i horisontella Logosolkuttrar.



Art.nummer	Pris/par:
7000-000-9502	315 kr

Justerkloss

För inställning av planhyvelstälens höjd.



Art.nummer	Pris:
7500-000-1020	60 kr

Mellanringar

För höjning av sidokuttrar. 2x5 st ringar med måtten 0,1; 0,2; 0,5; 1,0 och 2,0 mm.



Art.nummer	Pris:
7502-001-0230	70 kr

Kombinationer

Vi visar här hur några av de standardstål som för närvarande finns tillgängliga, kan kompletteras till olika färdiga profiler. Vårt sortiment med standardstål utökas kontinuerligt.

REGEL & TRALL

Rak

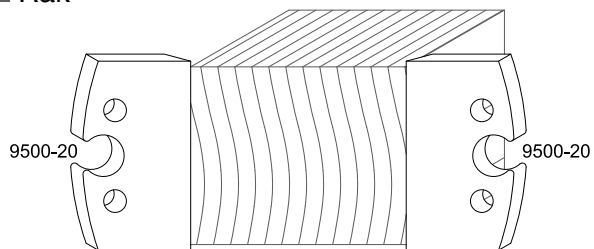

Avrundning, enkel

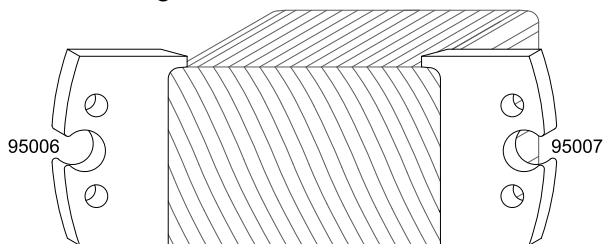

Avrundning, dubbel, 19 mm

Art. nr. 94275

ILLUSTRATION SAKNAS

Avrundning, dubbel, 22 mm

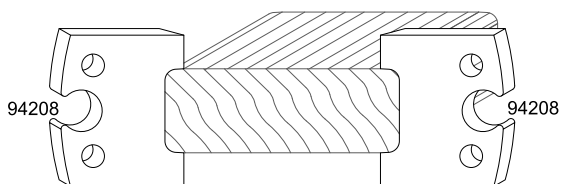

Avrundning, dubbel, 25 mm

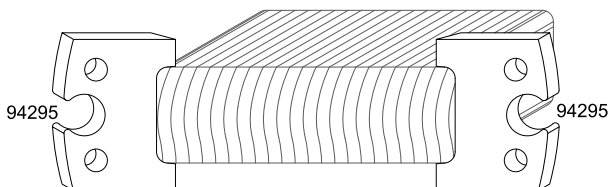

Avrundning, dubbel, 28 mm

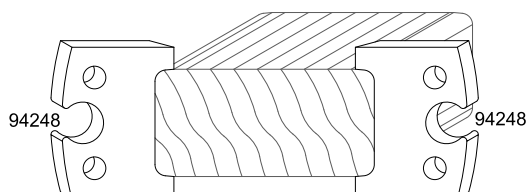

Avrundning, dubbel, 36 mm

Art. nr. 95080

ILLUSTRATION SAKNAS

Avrundning, dubbel, 38 mm

Art. nr. 95047

ILLUSTRATION SAKNAS

Avrundning, dubbel, 45 mm

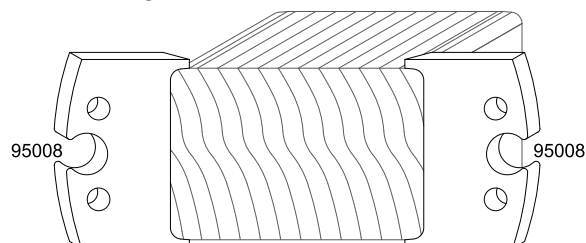

Avrundning, dubbel, 48 mm

Art. nr. 96017

ILLUSTRATION SAKNAS

NOT & SPONT

■ Not & Spont, 4 mm (tät 0,1 mm)

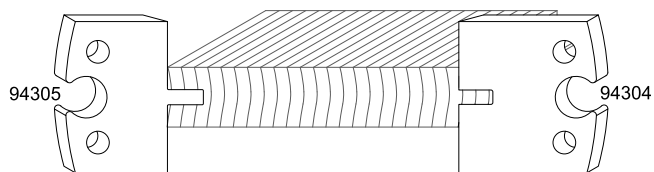

■ Not & Spont, 4,5 mm (tät 0,1 mm)

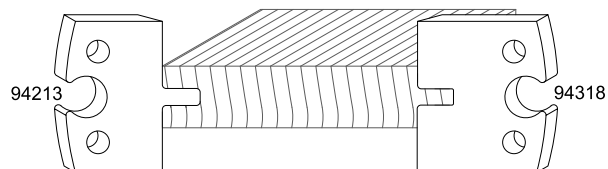

■ Not & Spont, 6 mm (tät 0,1 mm)

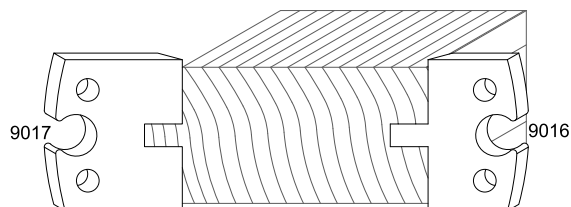

■ Not & Spont, 6 mm (Råspont)

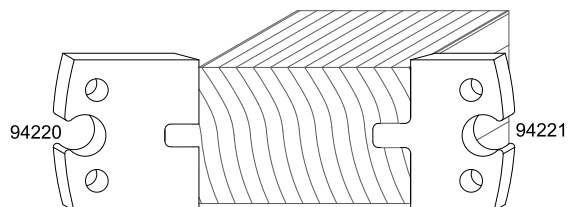

■ Not & Spont, 8 mm (tät 0,1 mm)

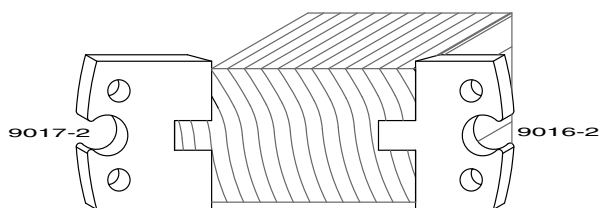

■ Not & Spont, 10 mm (tät 0,1 mm)

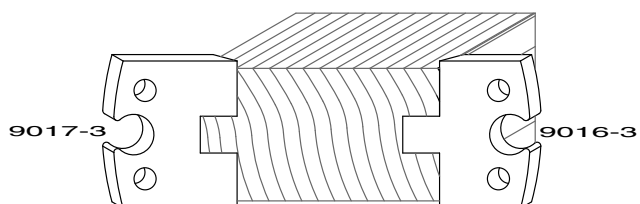

■ Not & Spont (Golvspont med spikfas)

Finns även utan fasad övre kant (Art. nr. 95056, 95057)

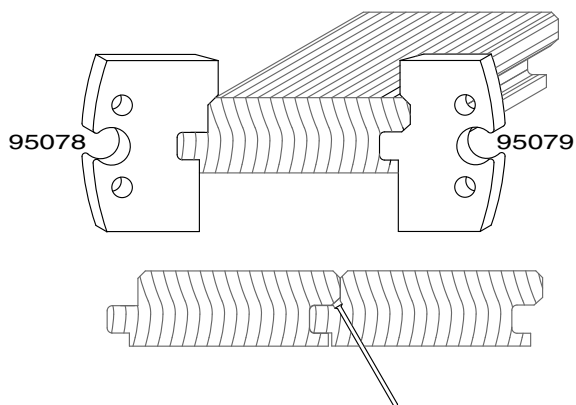

■ Not & Spont, 8 mm (Golvspont)

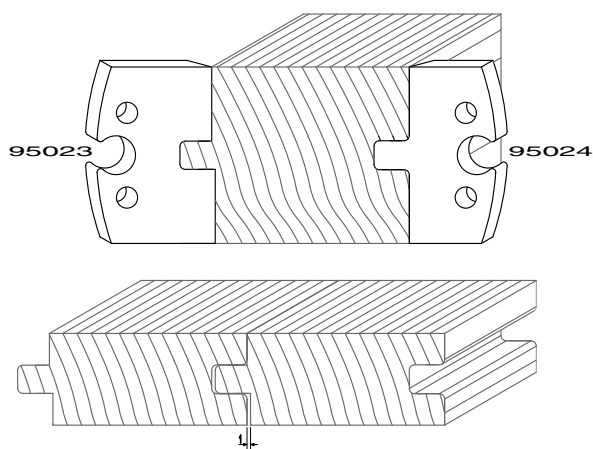

■ Not & Spont (Badkar, 33-41 mm)

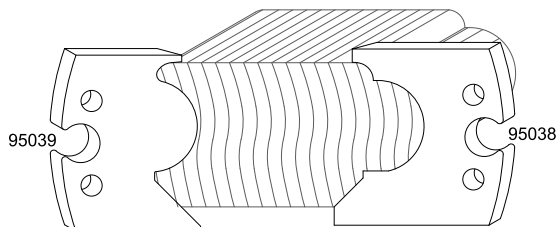

■ Not & Spont (Badkar, 41-45 mm)

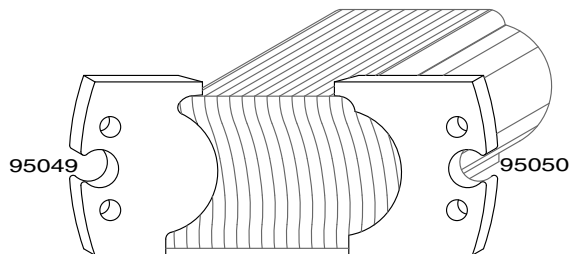

■ Not & Spont (Kantotstål, 5 mm radie)

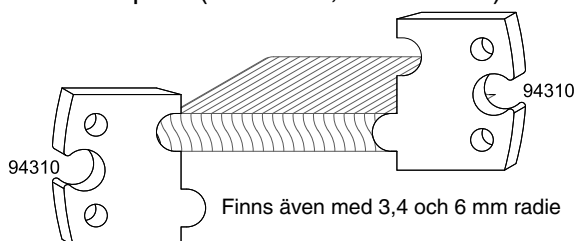

LOCKPANEL

■ Hattlock

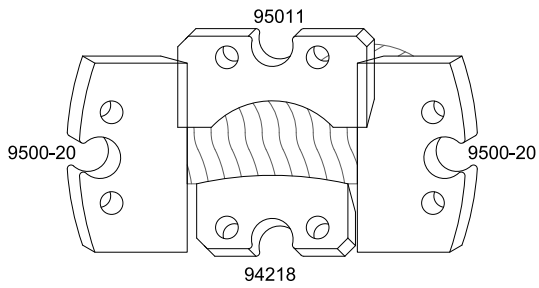

■ Faslock

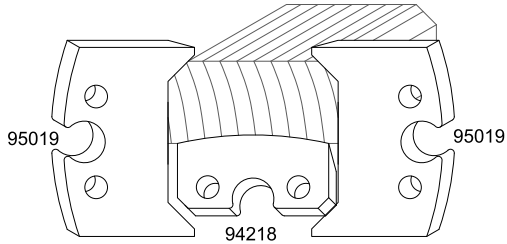

■ Dekorlock

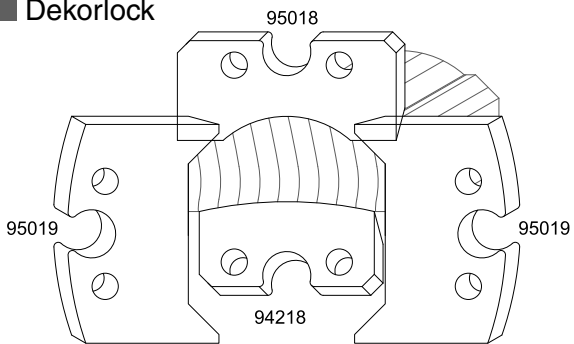

■ Dekorlock

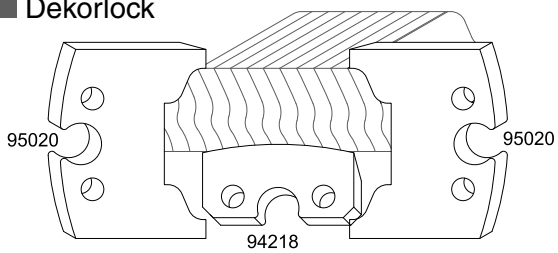

■ Dekorlock

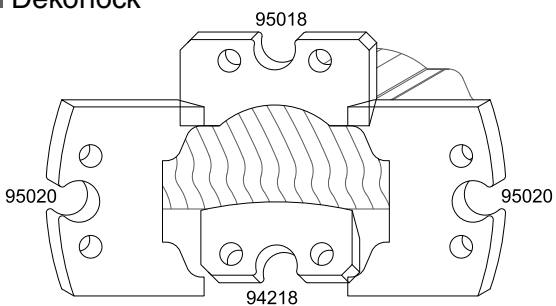

UTOMHUSPANELER

* För bättre resultat vid hyvling av ytterpaneler, rekommenderar Logosol fast fräs.

■ Faspanel

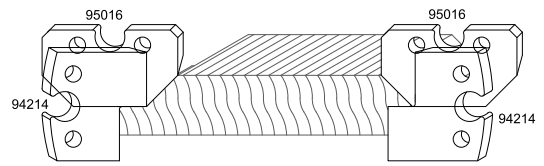

■ Faspanel, not 3 mm

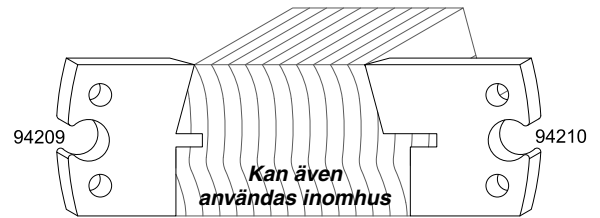

■ Faspanel, not 5 mm

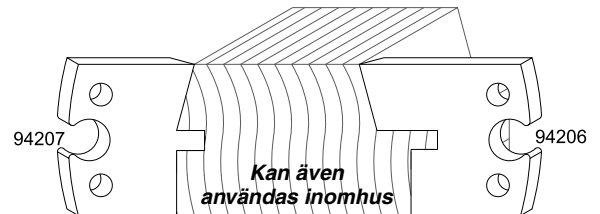

■ Avrundad panel

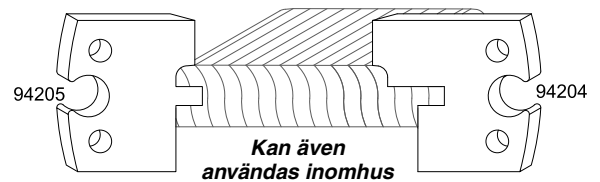

■ Hålkälspanel

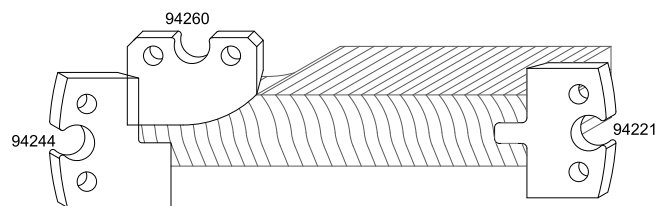

■ Stockpanel

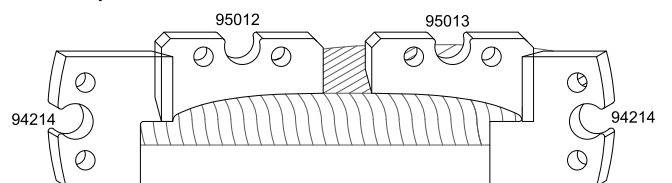

■ Norgepanel, svanhals

Stående not- och spontpanel med sågad framsida. 4-skärig kutter behövs.

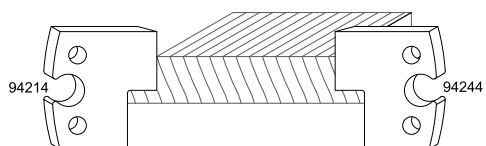
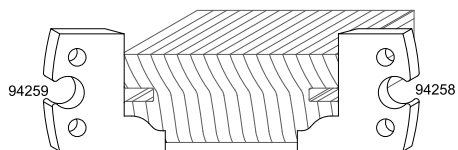
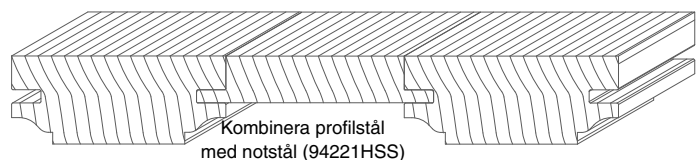

■ Norgepanel, hålkäl

Stående not- och spontpanel med sågad framsida. 4-skärig kutter behövs.

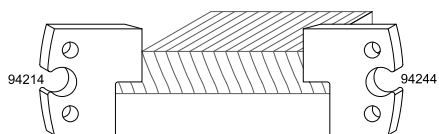
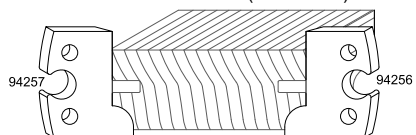
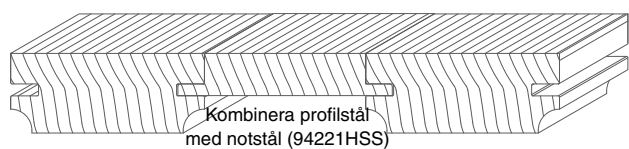

■ Stockhuspanel, 45 mm

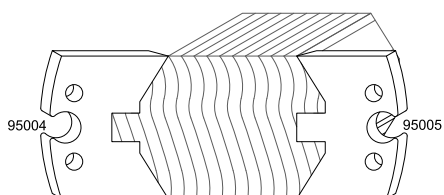

■ Stockhuspanel, 70 mm

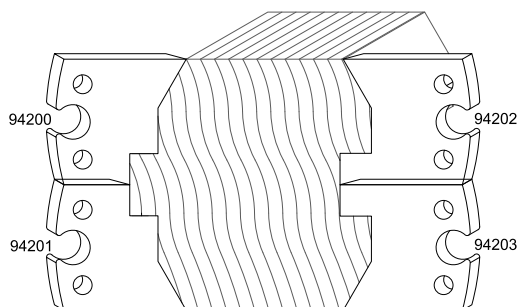

■ Friggebod

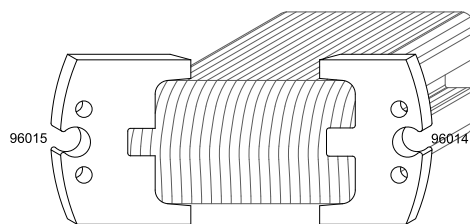

■ Friggebod

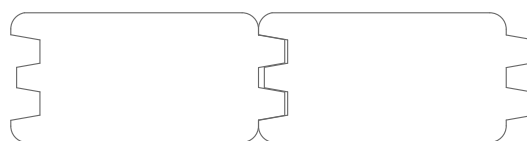
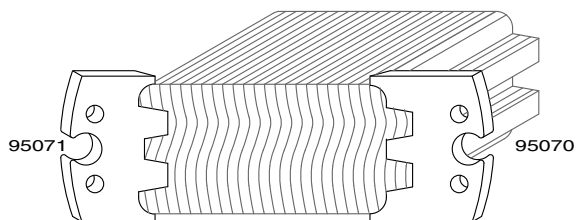

■ Fjällpanel

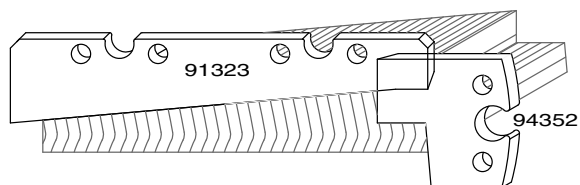

INOMHUSPANELER

■ Morapanel

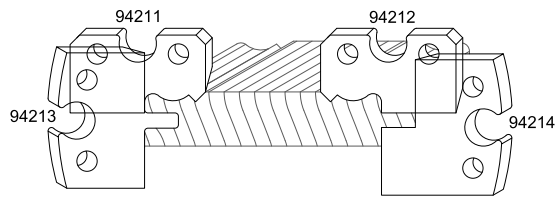

■ Pärlspont

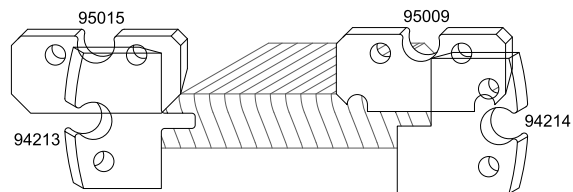

■ Pärlspont med 10 mm pärla

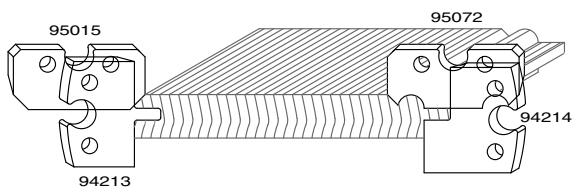

■ Avrundad panel

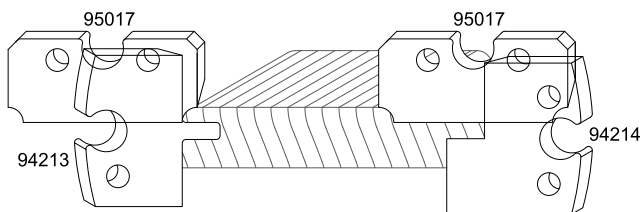

■ Faspanel

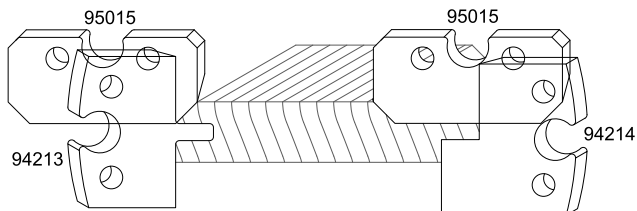

■ Faspanel, 45°

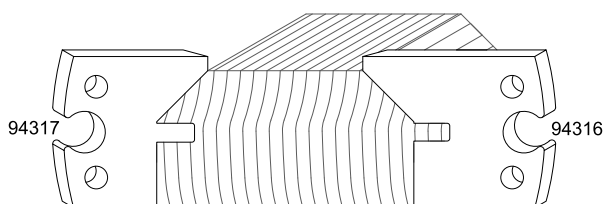

■ Faspanel, dubbel 45°

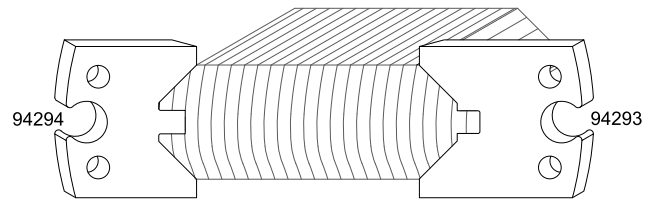

■ Pärlspont, 95 mm

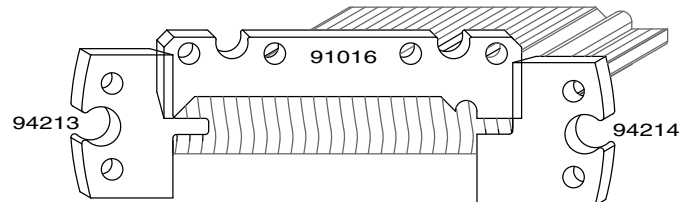

■ Pärlspont med 6 mm pärla och mittprofil

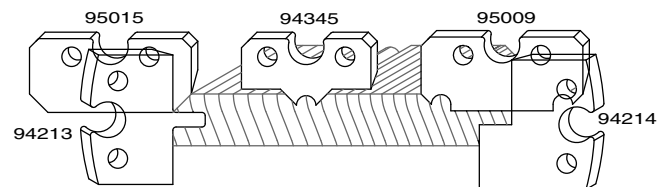

■ Faspanel med mittprofil

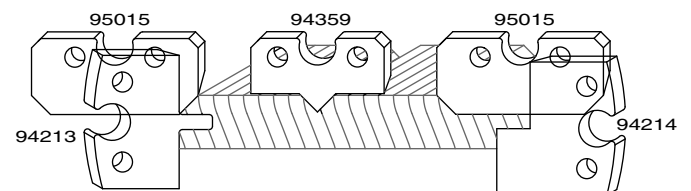

SPÅRNING & URFRÄSNING

■ Spårning av foder

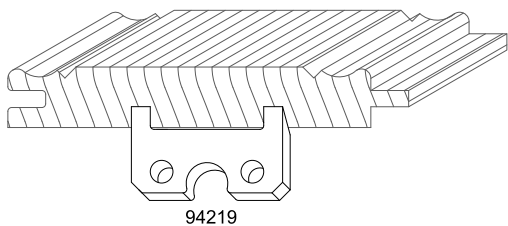

■ Urfräsning av foder

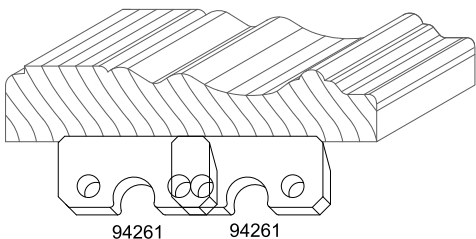

■ Urfräsning av golvlister

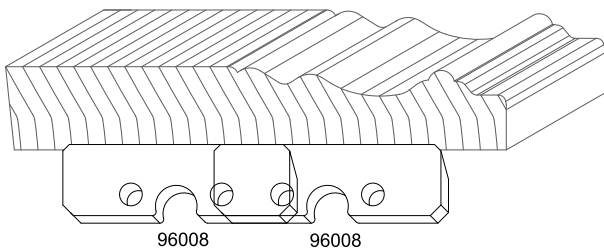

HÖRNBLOSS

■ Förbindning

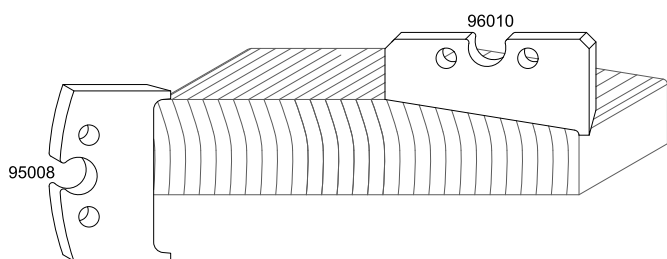

En dekorativ förbindningskloss för att få snygga avslutningar på olika lister. Mycket bra vid kraftiga profiler på listerna.

BRÖSTLIST

■ Rundad

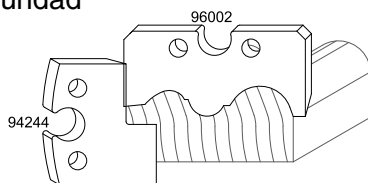

■ Profil

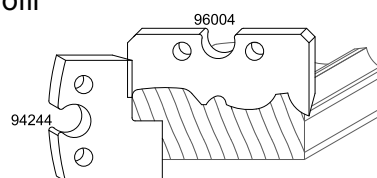

■ Profil

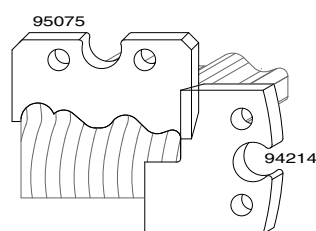

DEKORLIST

■ Dekorlist

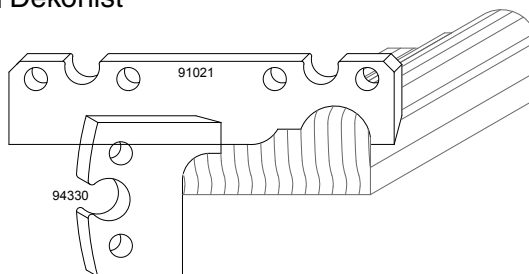

■ Dekorlist

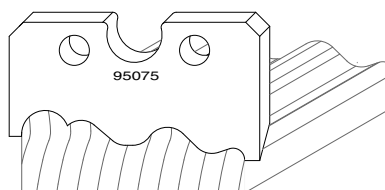

■ Dekorlist

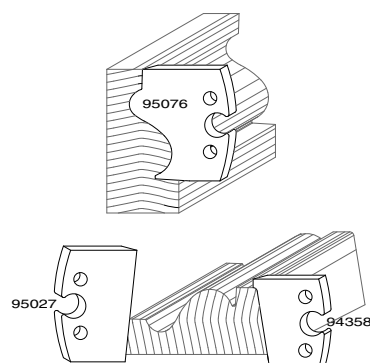

GOLVLIST

■ Smyglist

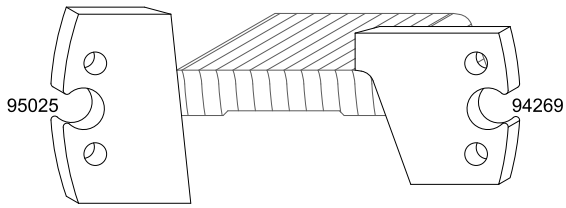

■ Stocklist

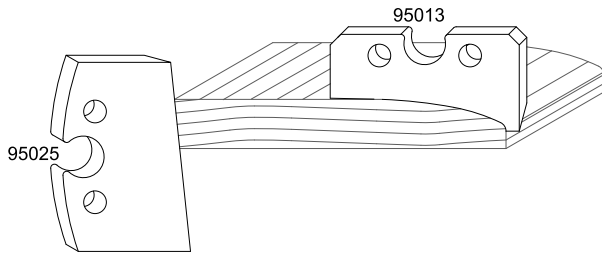

■ Svanhalslist

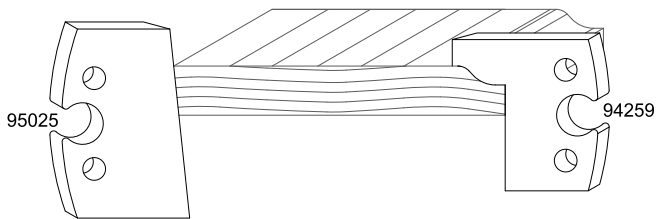

■ Kvartstavslist

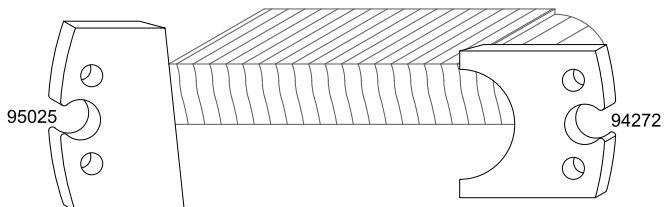

■ Allmogelist

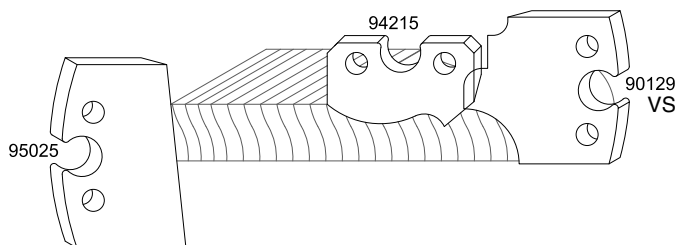

■ Hagalist

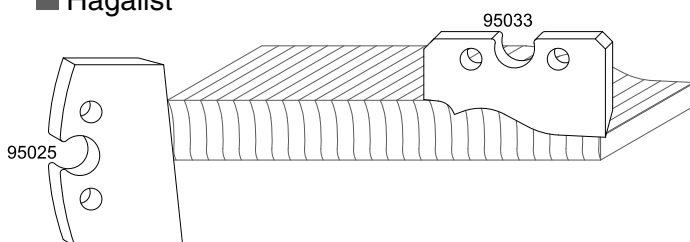

■ Gamlestadslist

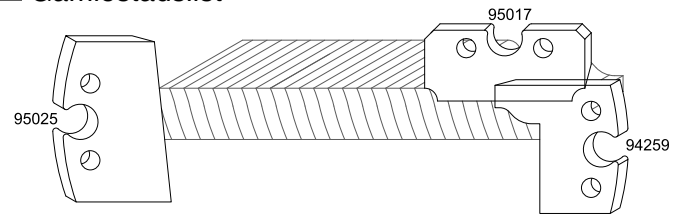

■ Stockholmslist

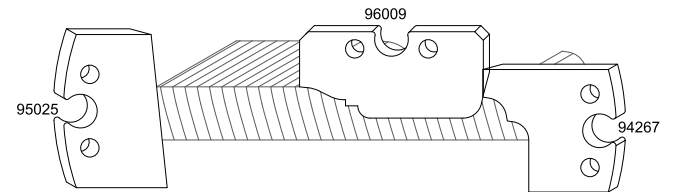

■ Gotlandslist

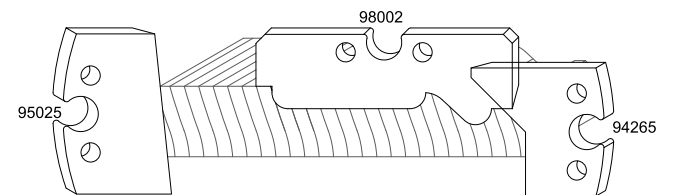

■ Hallandslist

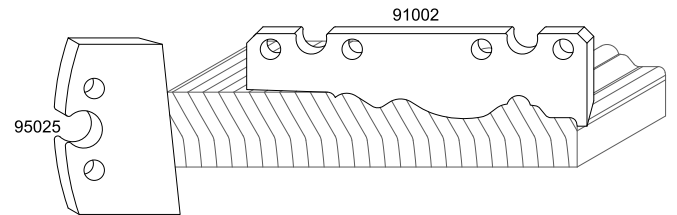

■ Golvlist

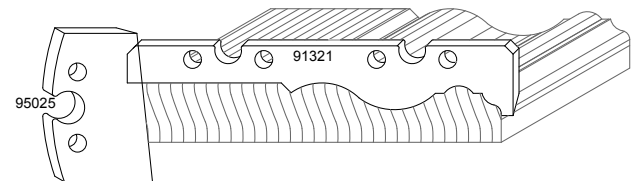

■ Golvlist

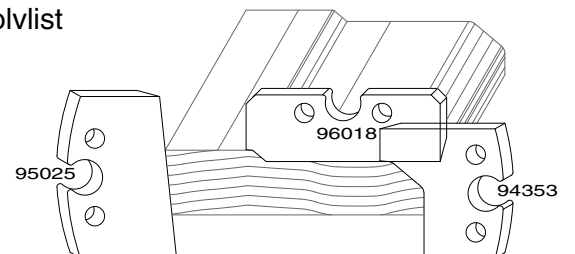

■ Golvlist

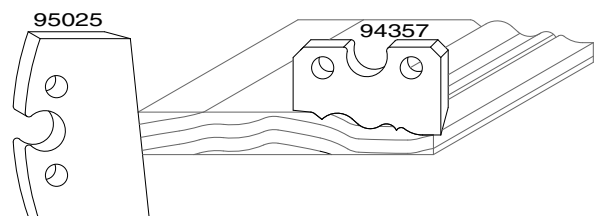

FODER

Allmogefoder

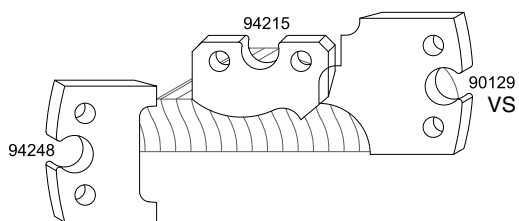

Dekorfoder, 70 mm

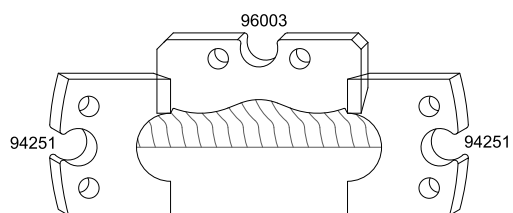

Dekorfoder, 95 mm

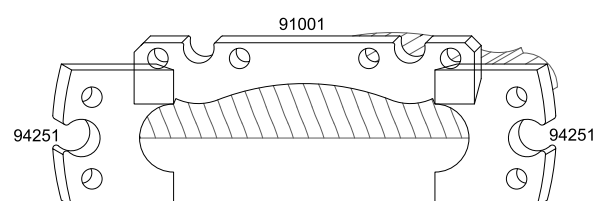

Fönsterfoder

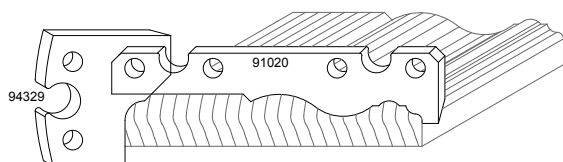

Amerikafoder, 57 mm

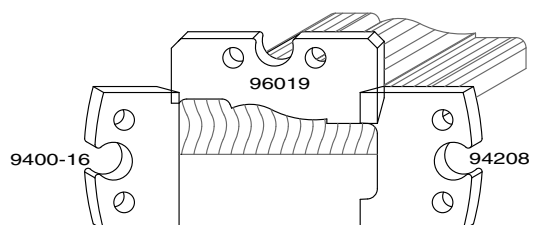

Amerikafoder

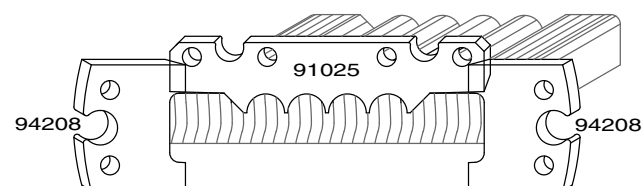

Foder

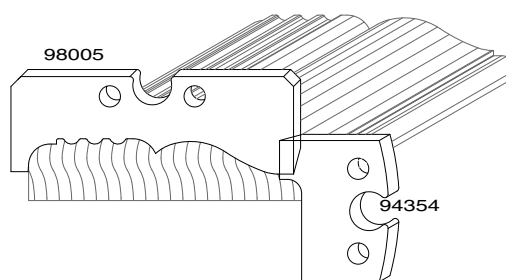

Foder

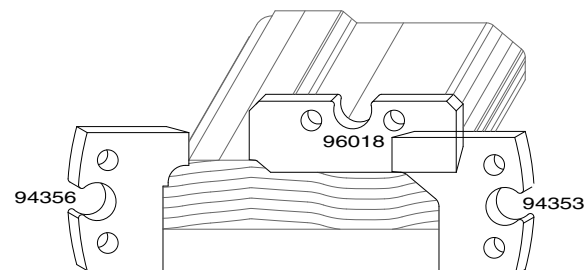

Foder

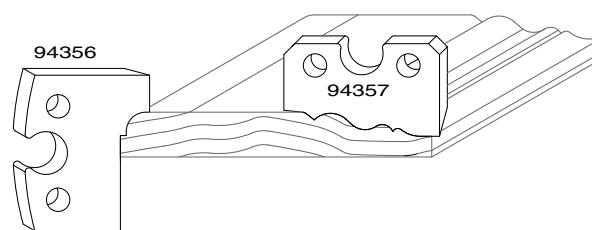

TAKLIST

■ Skugglist

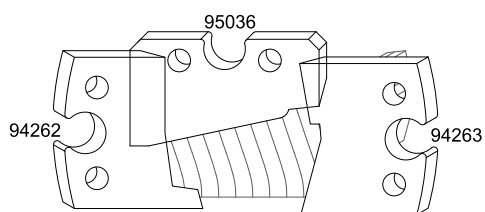

■ Trappstegslist

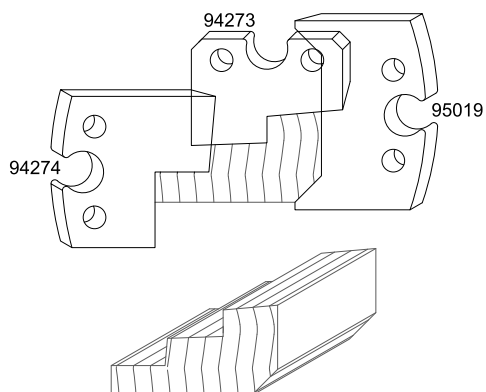

■ Kvantstavstaklist

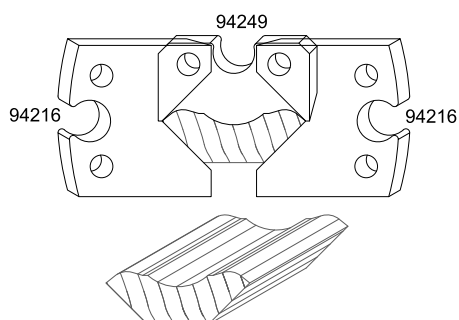

■ Profiltaklist, 70 mm

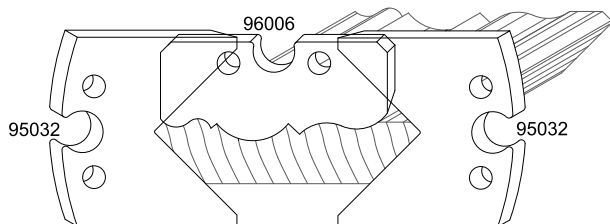

■ Svanhalstaklist, 45 mm

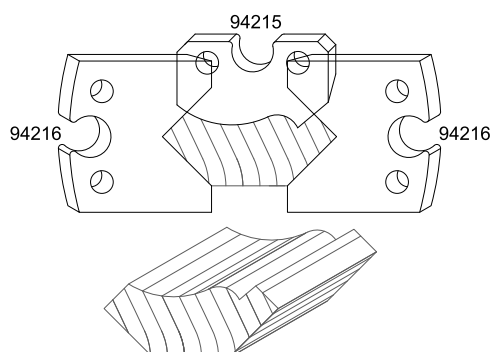

■ Svanhalstaklist, 56 mm

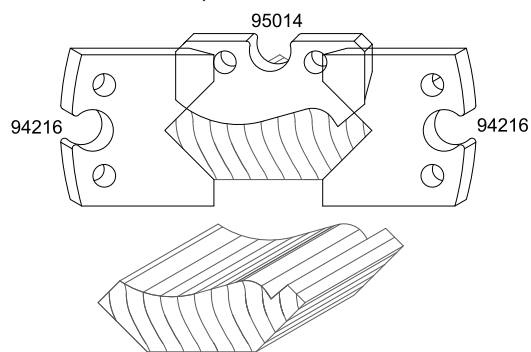

■ Svanhalstaklist, 68 mm

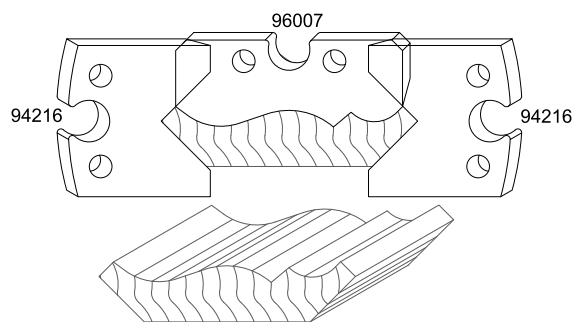

■ Svanhalstaklist, 80 mm

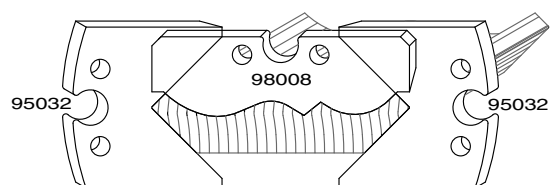

■ Svanhalstaklist, 80 mm

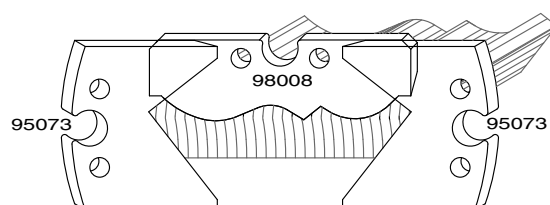

■ Svanhalstaklist, 95 mm

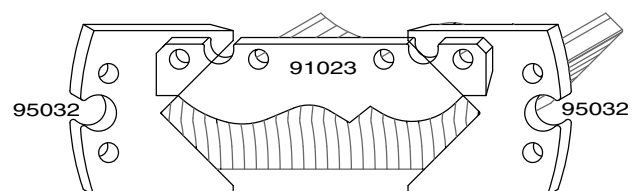

■ Svanhalstaklist, 95 mm

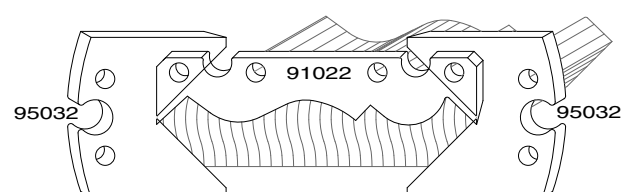

■ Svanhalstaklist, 120 mm

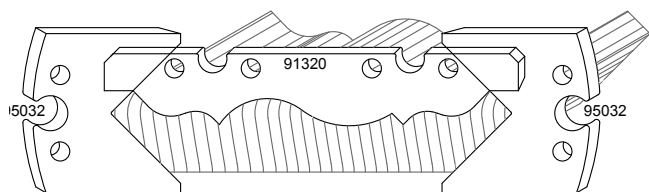

■ Svanhalstaklist, 120 mm

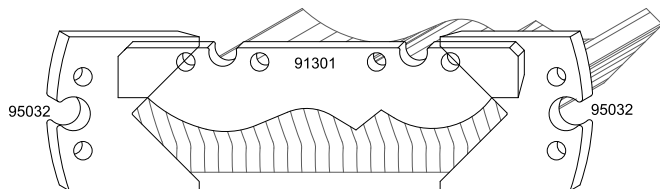

■ Hålkälstaklist, 45 mm

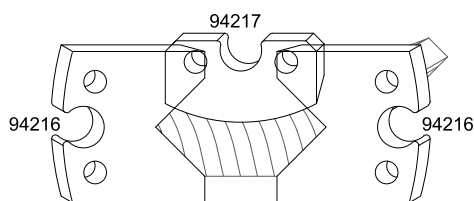

■ Hålkälstaklist, 60 mm

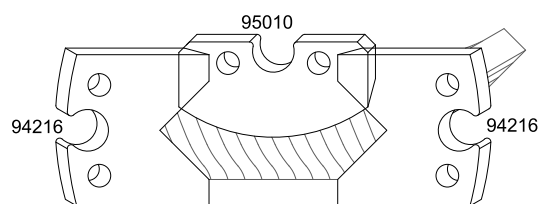

■ Hålkälstaklist, 70 mm

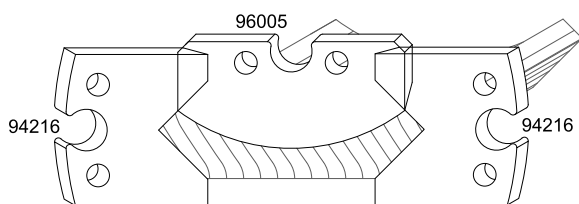

■ Hålkälstaklist, 95 mm

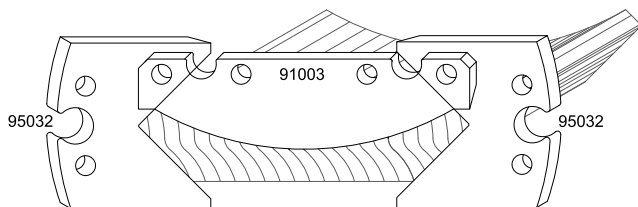

■ Taklist med skuggkant

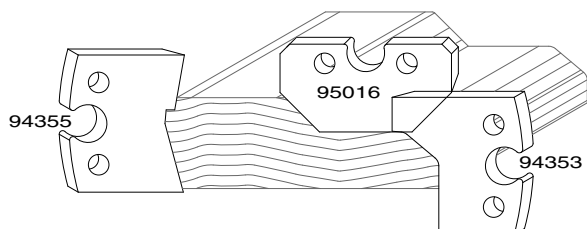

■ Stukaturlist

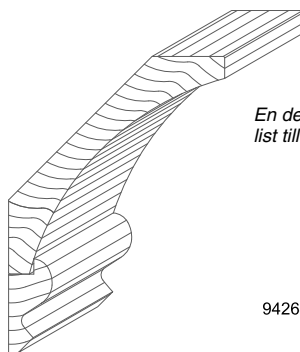

En dekorlist som kan användas som påbyggnadslist till andra lister eller bröstlist.

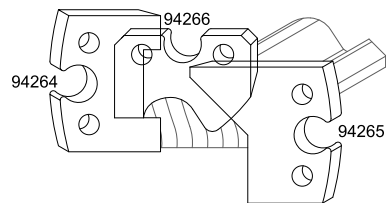

FALSSTÅL

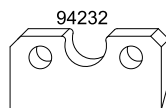

94232HSS
Detta stål ger 2 mm falsdjup

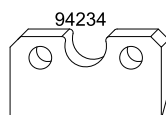

94234HSS
Detta stål ger 4 mm falsdjup

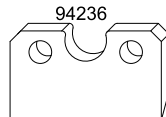

94236HSS
Detta stål ger 6 mm falsdjup

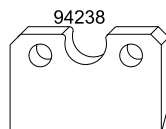

94238HSS
Detta stål ger 8 mm falsdjup

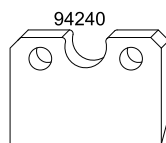

94240HSS
Endast Solohyveln!
Detta stål ger 10 mm falsdjup

KVARTSSTAV

■ Kvartsstav, 21 mm

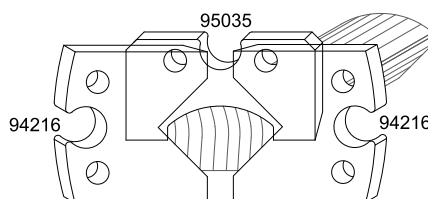

PELARE

Rund pelare

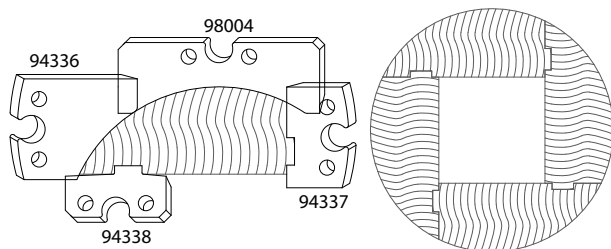

8-kantig pelare med stödfas

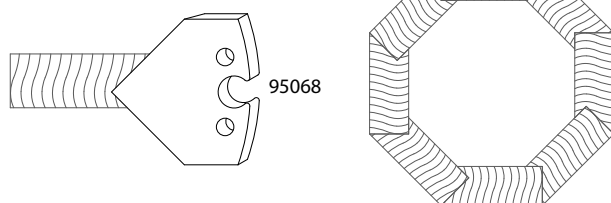

8-kantig pelare

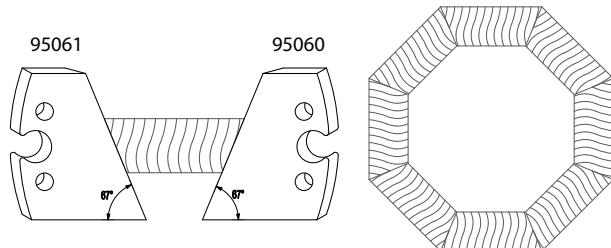

12-kantig pelare

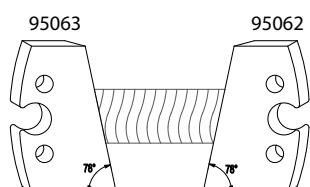

15-kantig pelare

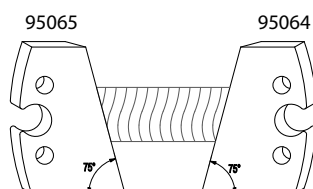

17-kantig pelare

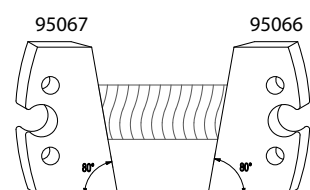

RUNDSTAV

Rundstav, 21 mm

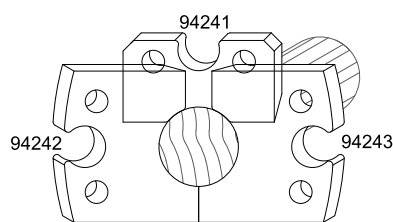

Rundstav, 24 mm

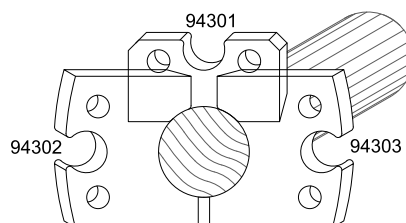

Rundstav, 27 mm

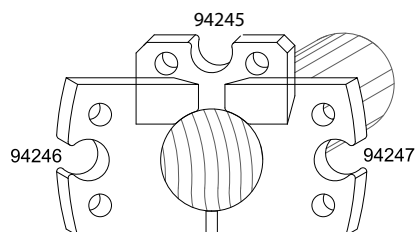

Rundstav, 40 mm

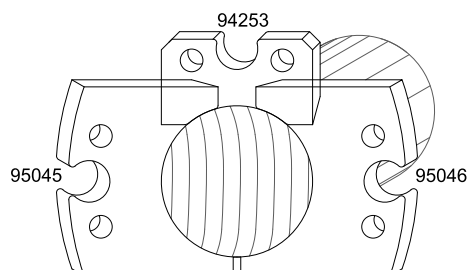

ÖVRIGA

Notställslist

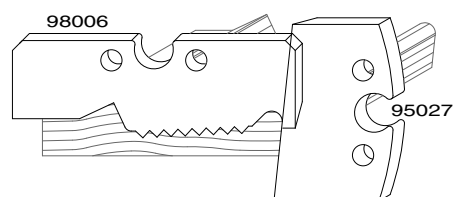

STÅL TILL SOLOHYVELN

PANEL

■ Rundad panel, 15 mm

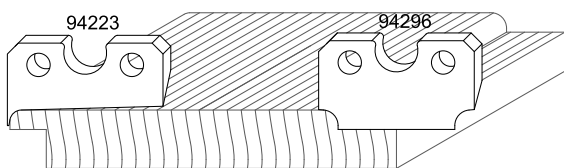
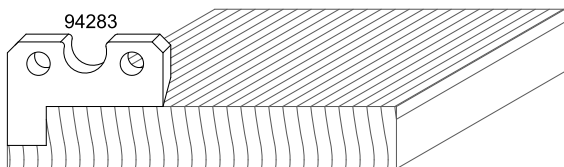

■ Faspanel, 15-20 mm

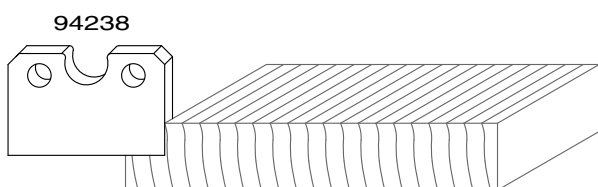

Starta med att hyvla en fals på baksidan.

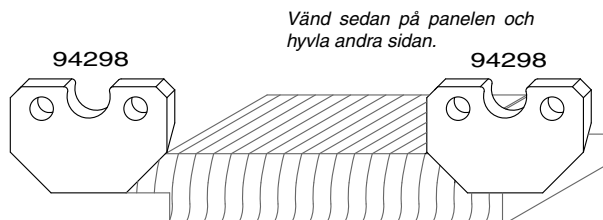

■ Faspanel, 15 mm

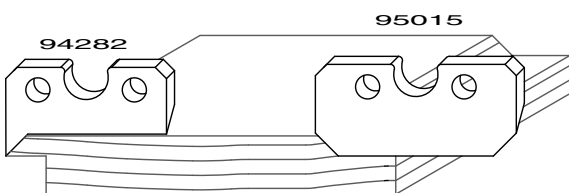
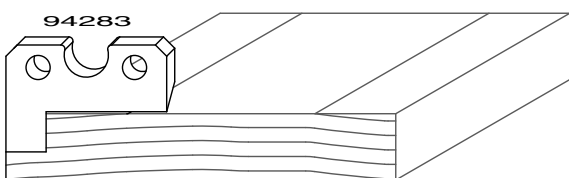

■ Pärlspont, 15 mm

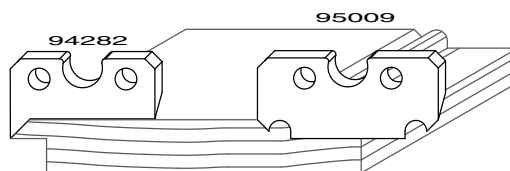
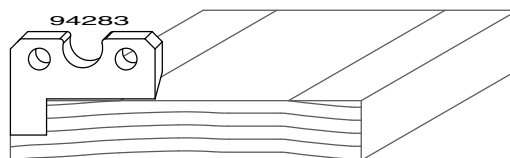

■ Pärlspont med vågig yta, 15 mm

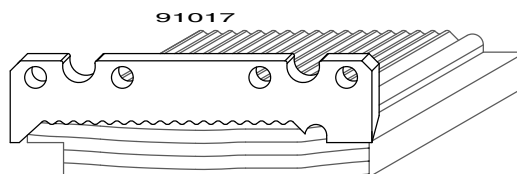
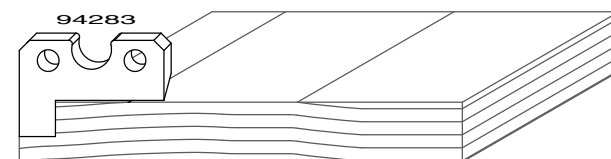

■ Morapanel, 15 mm

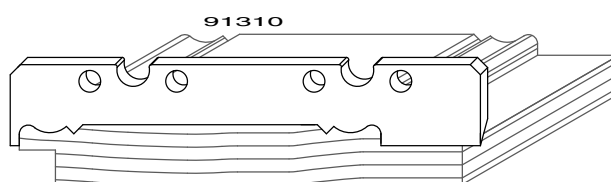
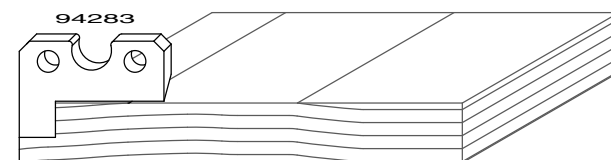

■ Stockpanel

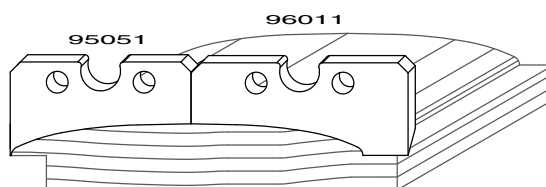
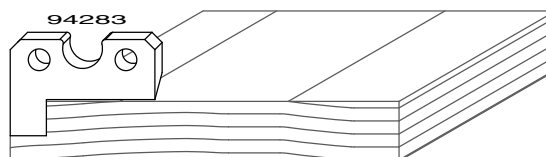

BRÖSTLIST

■ Allmoge bröstlist

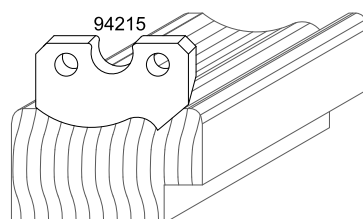
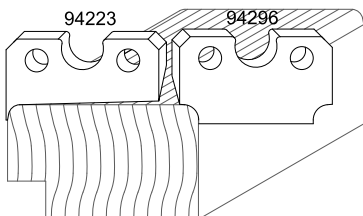
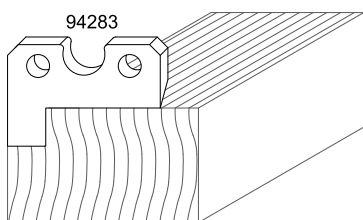

■ Rundad bröstlist

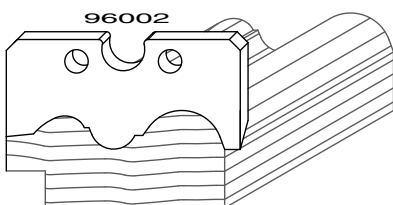
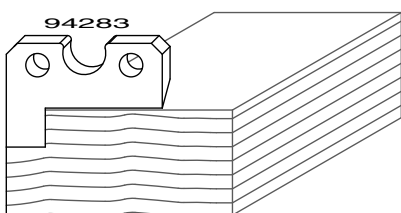

■ Bröstlistprofil

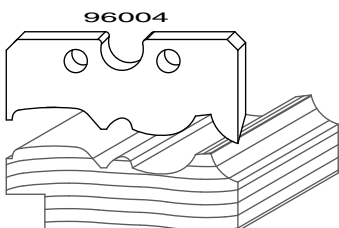
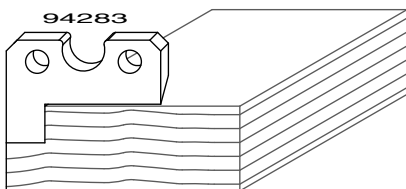

GOLVLIST

■ Allmoge

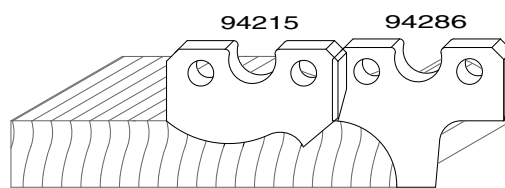

Plywoodskiva ska användas.

■ Rundad

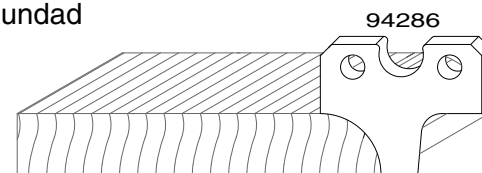

Plywoodskiva ska användas.

■ Hagalist

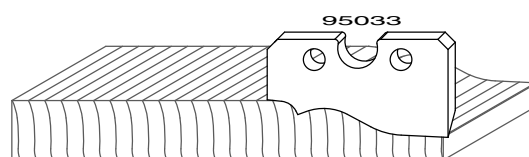

■ Hallandslist

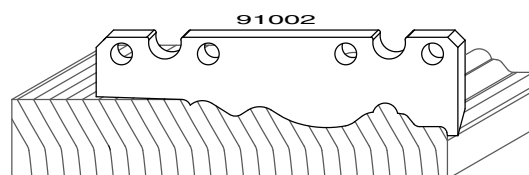

■ Stocklist

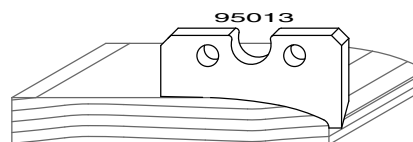

TAKLIST

■ Allmoge taklist

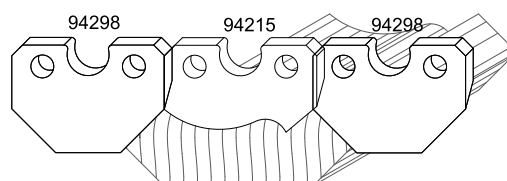
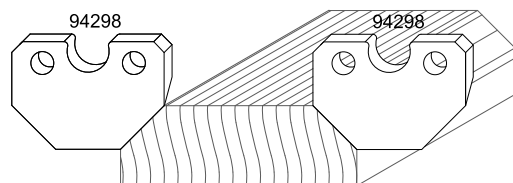

FODER

■ Rundat foder, 15 mm

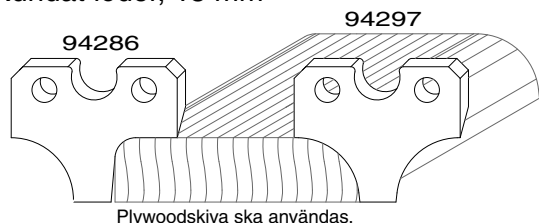

■ Rundat foder, 15 mm

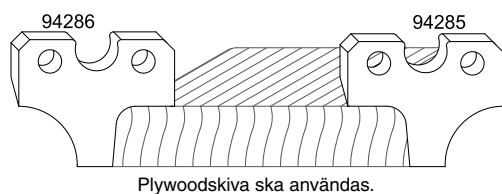

■ Allmogefoder, 15 mm

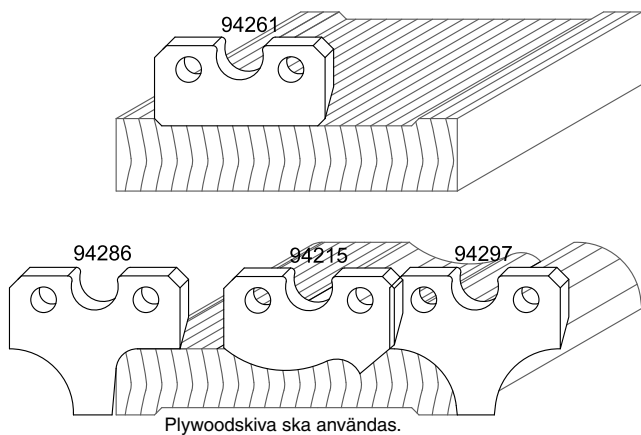

RUNDSTAV

■ Rundstav Solohyvel, 30 mm

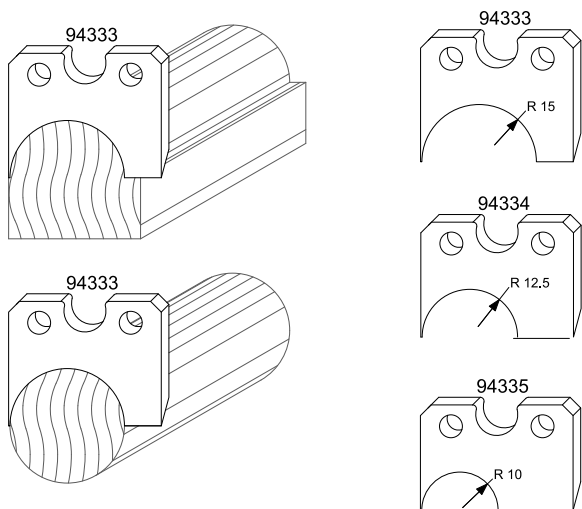

REGEL & TRALL

■ Stål för trallvirke

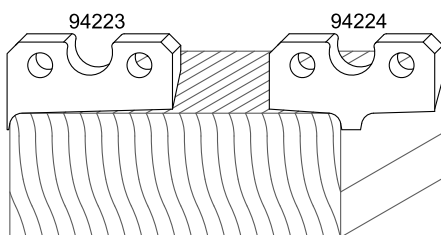

■ Stål för trallvirke

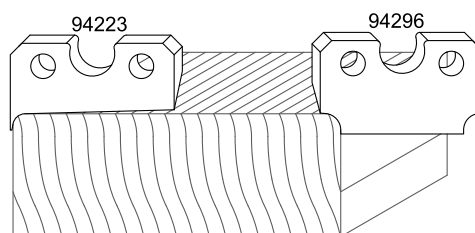

■ Trall med greppprofil

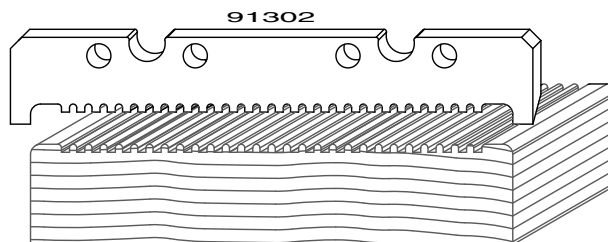

■ Trall med greppprofil

Kräver att planstålen tas bort.

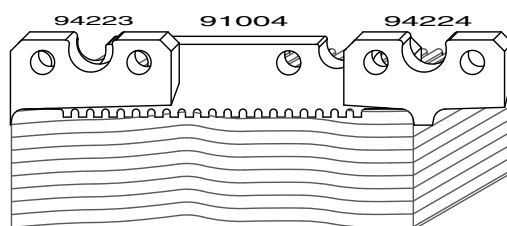

HÖRNKLOSS

■ Hörnkloss

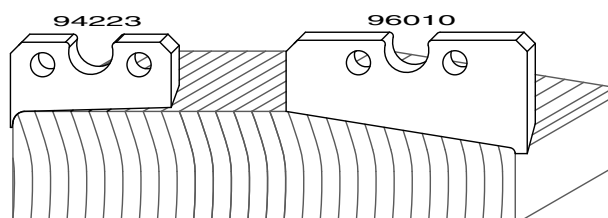

LOCKPANEL

■ Faslock

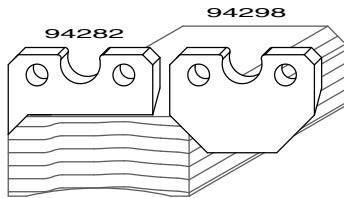
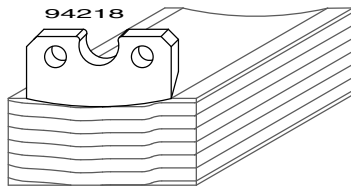

■ Hattlock

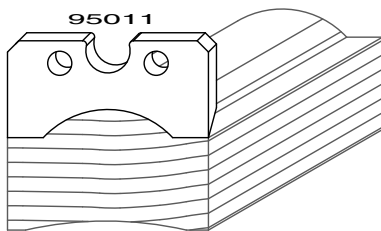
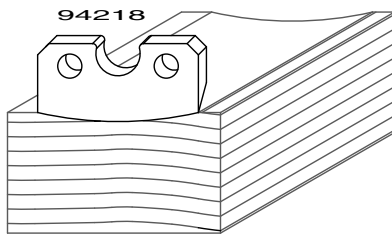

GOLV

■ Golvprofil

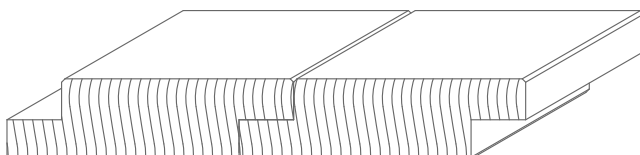
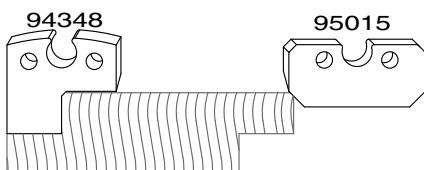
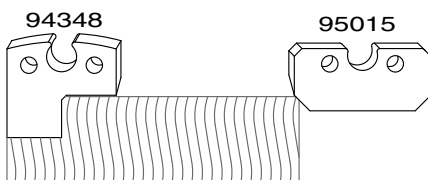

TAK

■ Spårad takpanel

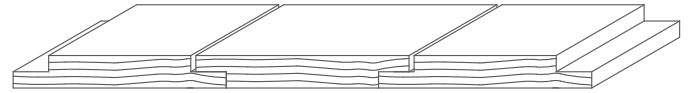
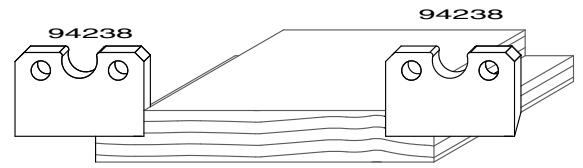

NOT & SPONT

■ Not & Spont Solohyvel

Ämnet hyvlas på högkant. Max. höjd är 52 mm.

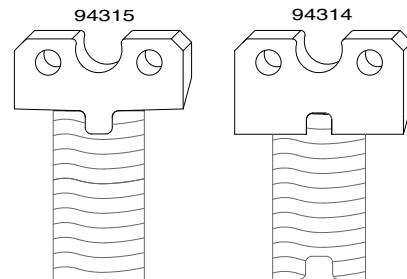

STÅLPAKET



Stål för tillverkning av paneler, dörr- och fönsterfoder, golvsocklar och taklistor. De kan göras släta, med svanhals, med rundning eller med fas.

En träskiva följer med i paketet. Denna läggs på hyvelbordet när stål med utstick över 15 mm används i maskinen.

Följande stålpar ingår i stålpaketet:

94215HSS, 94223HSS, 94261HSS, 94283HSS, 94286HSS, 94296HSS, 94297HSS, 94298HSS + 6 st kutterkilar.

ART.NR:	PRODUKT:	PRIS:
7202-001-1500	Stålpaket till SH230	3 700,-

Profilstål i HSS

Stål med hög slitstyrka, lämpade för serieproduktion. Skärpan håller i 3000-6000 löpmeter. Kan skäras 5 till 10 gånger med Tormek slipmaskin utrustad med slippigg för profilstål.

40 mm

■ 94200HSS

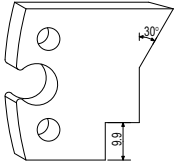

■ 94201HSS

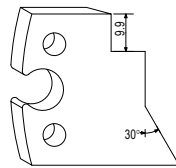

■ 94202HSS

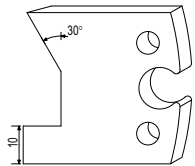

■ 94203HSS

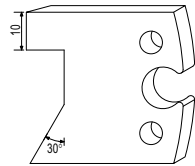

■ 94204HSS

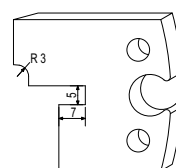

■ 94205HSS

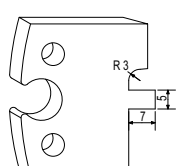

■ 94206HSS

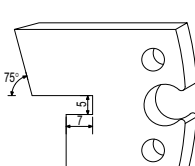

■ 94207HSS

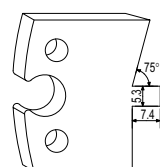

■ 94208HSS

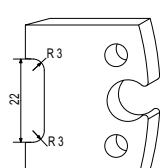

■ 94209HSS

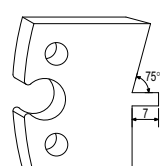

■ 94210HSS

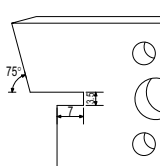

■ 94211HSS

Anpassat för DH410

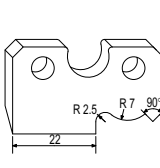

■ 94212HSS

Anpassat för DH410

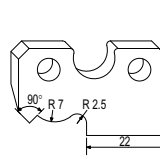

■ 94213HSS

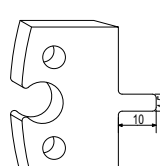

■ 94214HSS

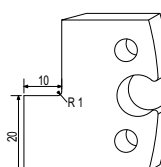

■ 94215HSS

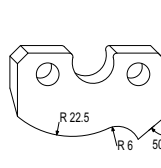

■ 94216HSS

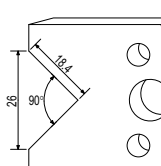

■ 94217HSS

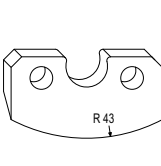

■ 94218HSS

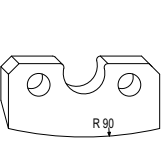

■ 94219HSS

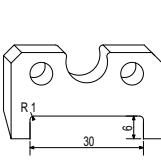

■ 94220HSS

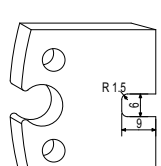

■ 94221HSS

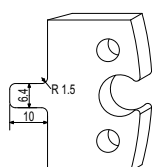

■ 94223HSS

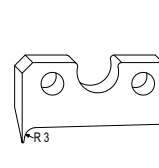

■ 94224HSS

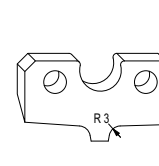

■ 94229HSS

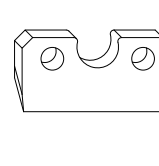

■ 94232HSS

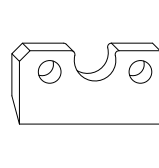

■ 94234HSS

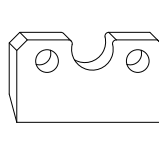

■ 94236HSS

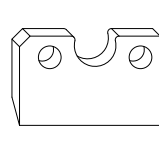

■ 94238HSS

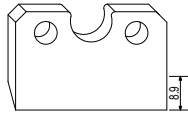

■ 94240HSS
Endast Solohyveln.

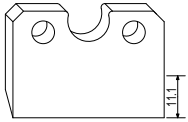

■ 94241HSS

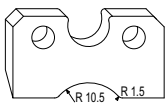

■ 94242HSS

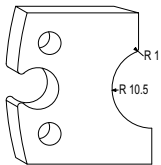

■ 94243HSS

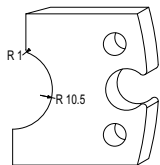

■ 94244HSS

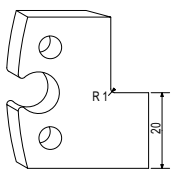

■ 94245HSS

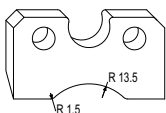

■ 94246HSS

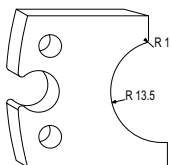

■ 94247HSS

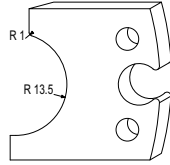

■ 94248HSS

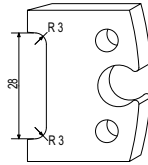

■ 94249HSS

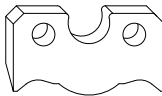

■ 94250HSS

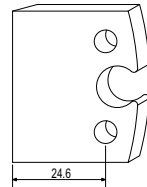

■ 94251HSS

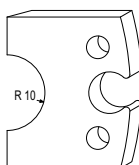

■ 94253HSS

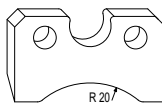

■ 94255HSS



■ 94256HSS

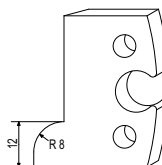

■ 94257HSS

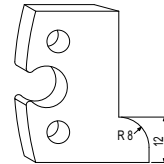

■ 94258HSS

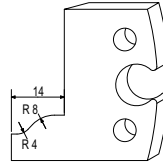

■ 94259HSS

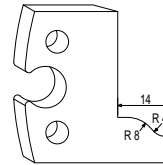

■ 94260HSS

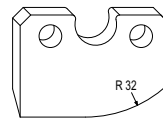

■ 94261HSS

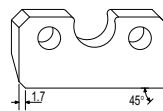

■ 94262HSS

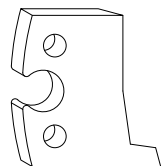

■ 94263HSS

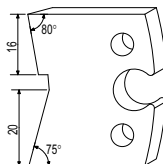

■ 94264HSS

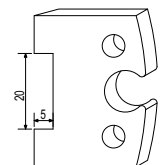

■ 94265HSS

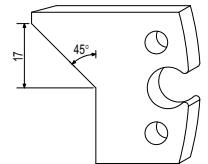

■ 94266HSS

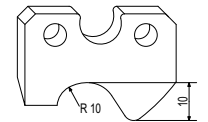

■ 94267HSS

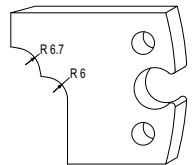

■ 94269HSS

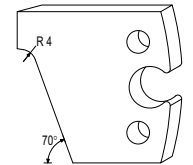

■ 94271HSS

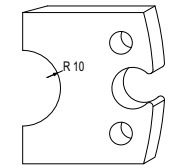

■ 94272HSS

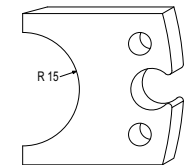

■ 94273HSS

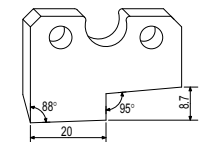

■ 94274HSS

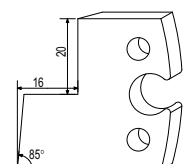

■ 94275HSS

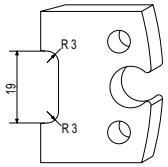

■ 94276HSS

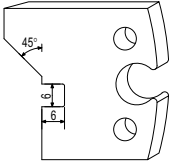

■ 94277HSS

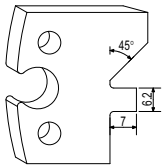

■ 94278HSS

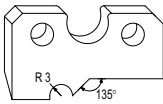

■ 94279HSS

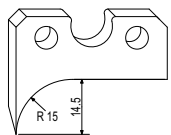

■ 94280HSS

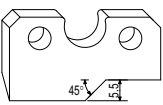

■ 94281HSS
Anpassat för DH410

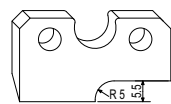

■ 94282HSS

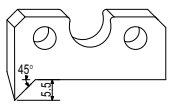

■ 94283HSS

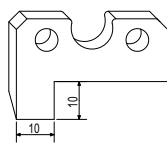

■ 94285HSS
Endast Solohyveln.
Plywoodskiva ska användas.

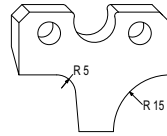

■ 94286HSS
Endast Solohyveln.
Plywoodskiva ska användas.

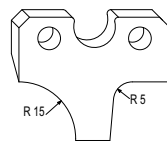

■ 94287HSS
Anpassat för DH410

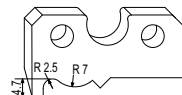

■ 94289HSS

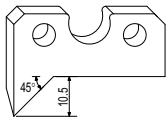

■ 94290HSS

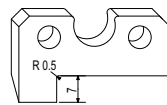

■ 94293HSS

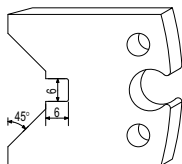

■ 94294HSS

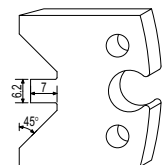

■ 94295HSS

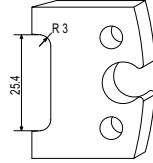

■ 94296HSS

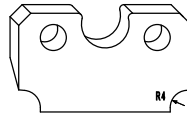

■ 94297HSS
Endast Solohyveln.
Plywoodskiva ska användas.

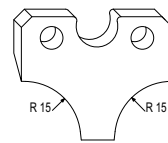

■ 94298HSS
Endast Solohyveln.
Plywoodskiva ska användas.

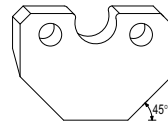

■ 94300HSS

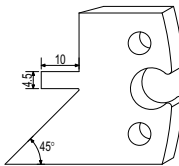

■ 94301HSS

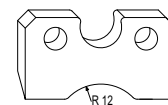

■ 94302HSS

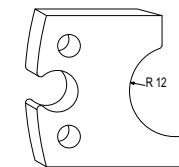

■ 94303HSS

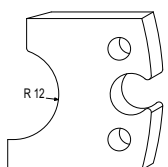

■ 94304HSS

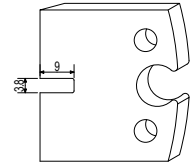

■ 94305HSS

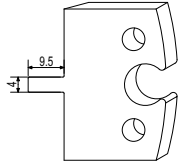

■ 94306HSS

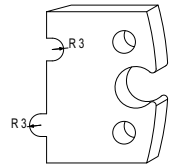

■ 94308HSS

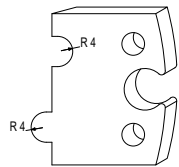

■ 94310HSS

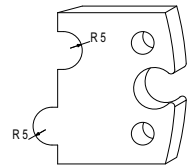

■ 94312HSS

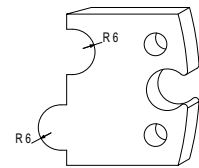

■ 94314HSS
Framtagen för Solohyveln

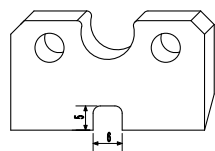

■ 94315HSS
Framtagen för Solohyveln

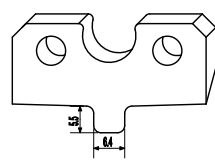

■ 94316HSS

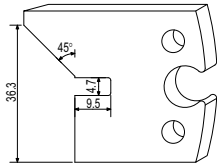

■ 94317HSS

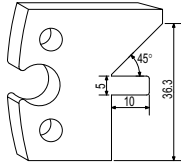

■ 94318HSS

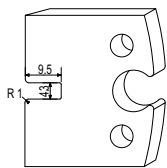

■ 94319HSS

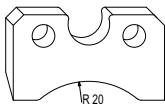

■ 94320HSS

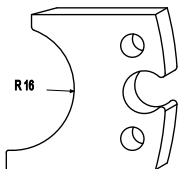

■ 94329HSS

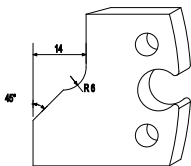

■ 94330HSS

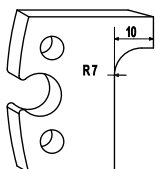

■ 94331HSS

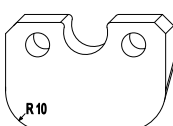

■ 94332HSS

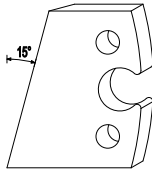

■ 94333HSS

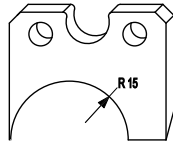

■ 94334HSS

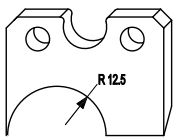

■ 94335HSS

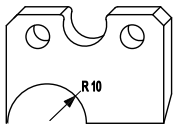

■ 94338HSS

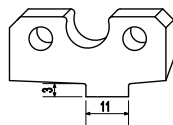

■ 94339HSS

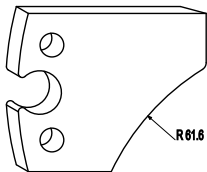

■ 94340HSS

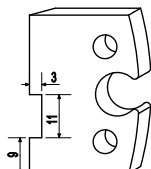

■ 94341HSS

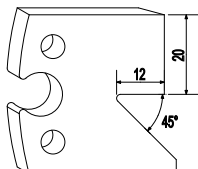

■ 94342HSS

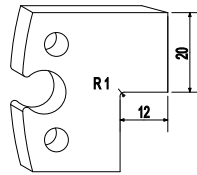

■ 94348HSS

Varning! Stort utstick.

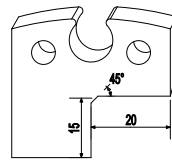

■ 94349HSS

Varning! Stort utstick.

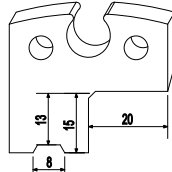

■ 94350HSS

Varning! Stort utstick.

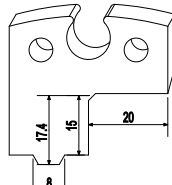

■ 94351HSS

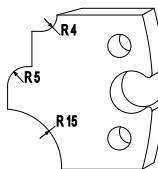

■ 94352HSS

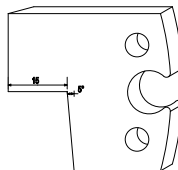

■ 94353HSS

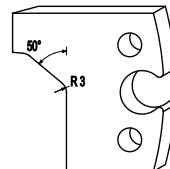

■ 94354HSS

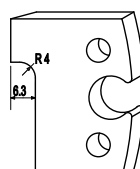

■ 94355HSS

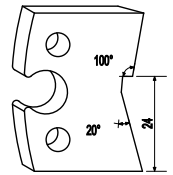

■ 94356HSS

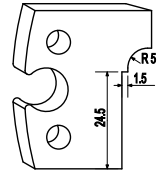

■ 94357HSS

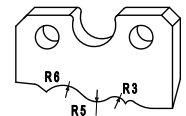

■ 94358HSS

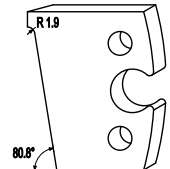

■ 94359HSS

Utstick 5 mm

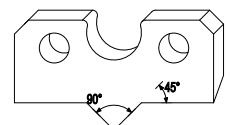

■ 94360HSS

Utstick 10 mm

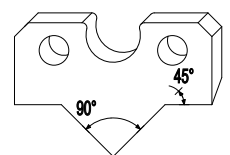

■ 94361HSS

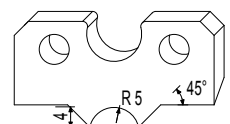

50 mm

■ 9500-20HSS

Finns även i 9500-16, 9500-24, 9500-32

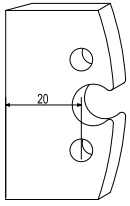

■ 95001HSS

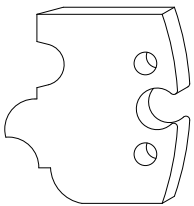

■ 95002HSS

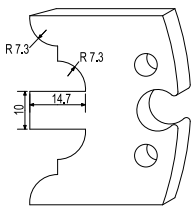

■ 95003HSS

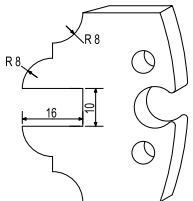

■ 95004HSS

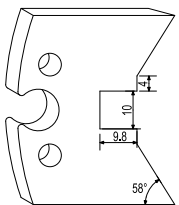

■ 95005HSS

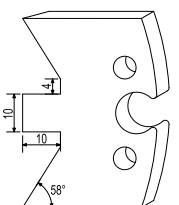

■ 95006HSS

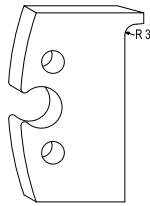

■ 95007HSS

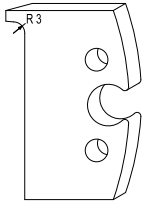

■ 95008HSS

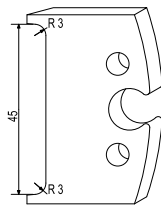

■ 95009HSS

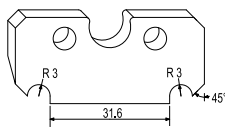

■ 95010HSS

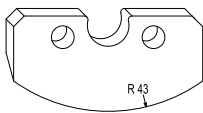

■ 95011HSS

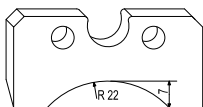

■ 95012HSS

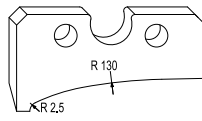

■ 95013HSS

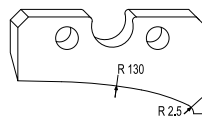

■ 95014HSS

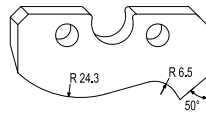

■ 95015HSS

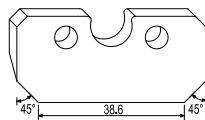

■ 95016HSS

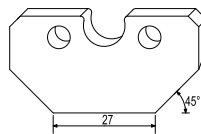

■ 95017HSS

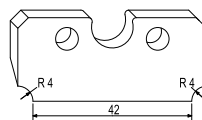

■ 95018HSS

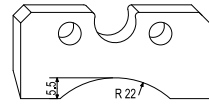

■ 95019HSS

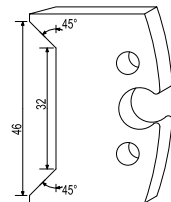

■ 95020HSS

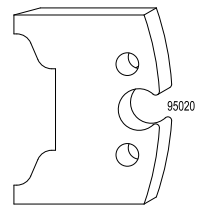

■ 95021HSS

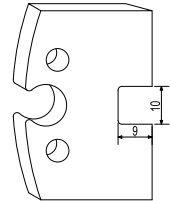

■ 95022HSS

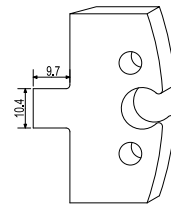

■ 95023HSS

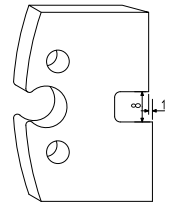

■ 95024HSS

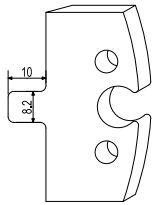

■ 95025HSS

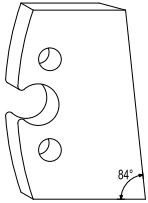

■ 95026HSS

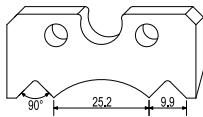

■ 95027HSS

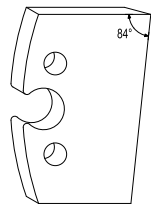

■ 95028HSS
Endast Solohyveln

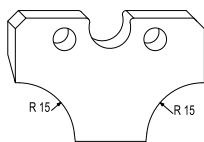

■ 95029HSS
10 mm utstick.

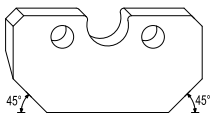

■ 95032HSS

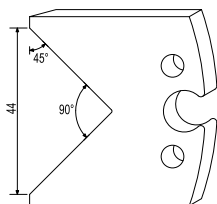

■ 95033HSS

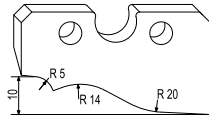

■ 95034HSS

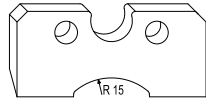

■ 95035HSS

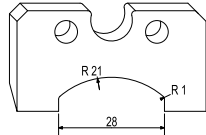

■ 95036HSS

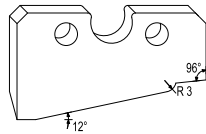

■ 95038HSS
Badkarsstål (33-41 mm material)

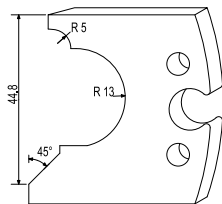

■ 95039HSS
Badkarsstål (33-41 mm material)

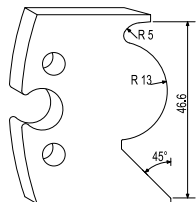

■ 95040HSS

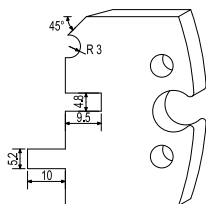

■ 95041HSS

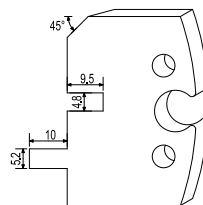

■ 95042HSS

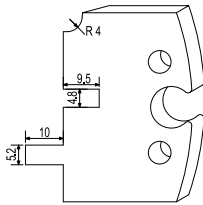

■ 95043HSS

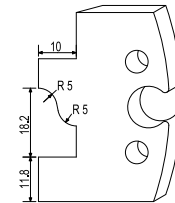

■ 95044HSS

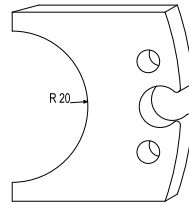

■ 95045HSS

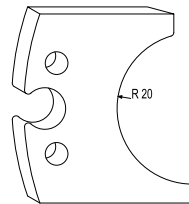

■ 95046HSS

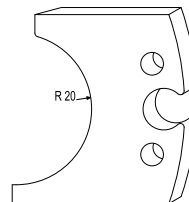

■ 95047HSS

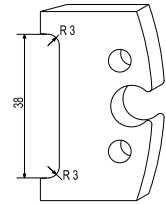

■ 95048HSS

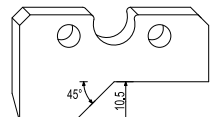

■ 95049HSS
Badkarsstål (41-45 mm material)

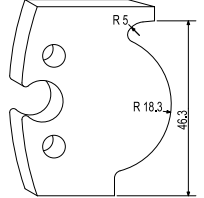

■ 95050HSS
Badkarsstål (41-45 mm material)

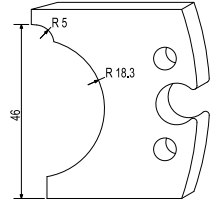

■ 95051HSS

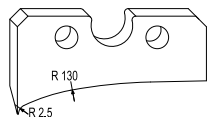

■ 95052HSS

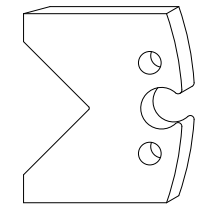

■ 95053HSS

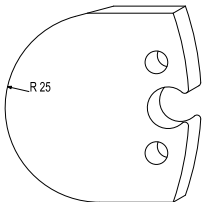

■ 95054HSS

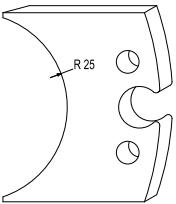

■ 95055HSS

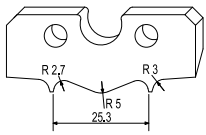

■ 95056HSS

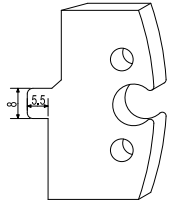

■ 95057HSS

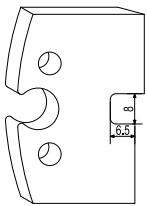

■ 95058HSS

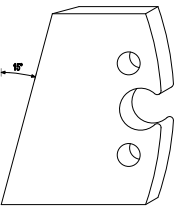

■ 95059HSS

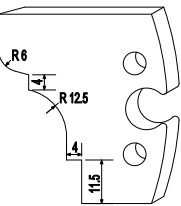

■ 95060HSS

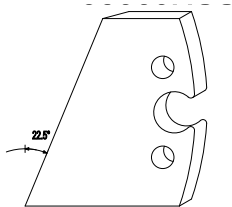

■ 95061HSS

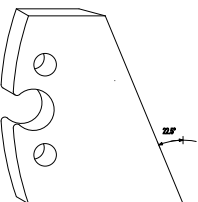

■ 95062HSS

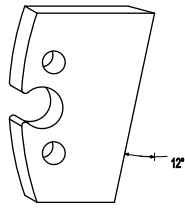

■ 95063HSS

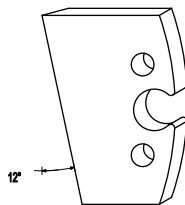

■ 95064HSS

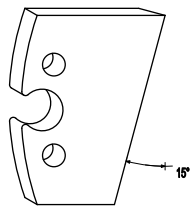

■ 95065HSS

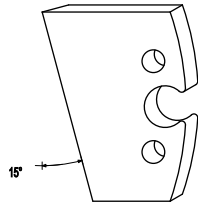

■ 95066HSS

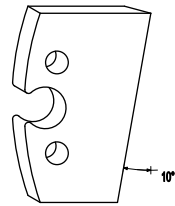

■ 95067HSS

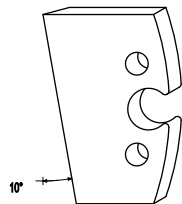

■ 95068HSS

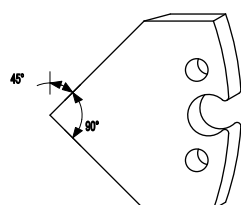

■ 95070HSS

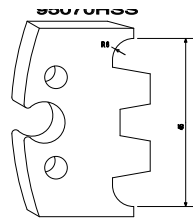

■ 95071HSS

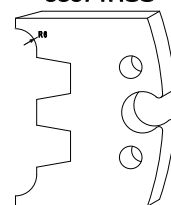

■ 95072HSS

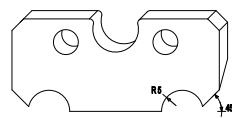

■ 95073HSS

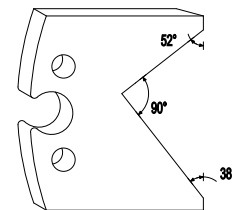

■ 95074HSS

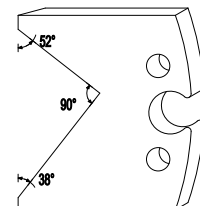

■ 95075HSS

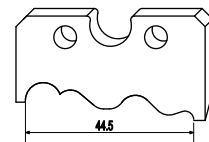

■ 95076HSS

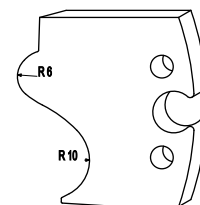

■ 95077HSS

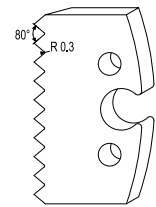

■ 95078HSS

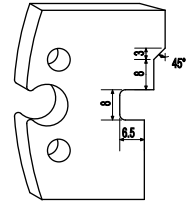

■ 95079HSS

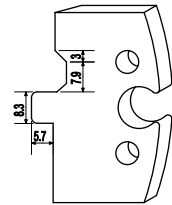

■ 95080HSS

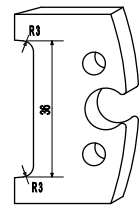

60 mm

9600-20HSS

Finns även i 9600-16, 9600-24, 9600-32

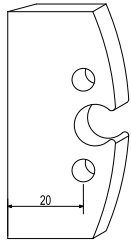

96001HSS

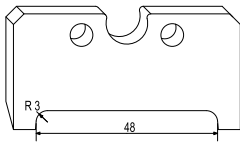

96002HSS

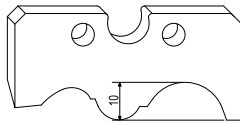

96003HSS

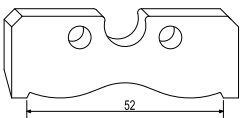

96004HSS

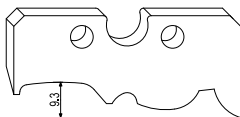

96005HSS

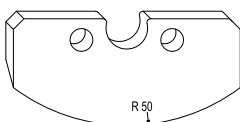

96006HSS

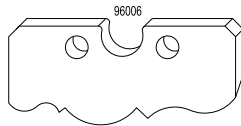

96007HSS

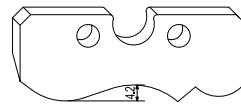

96008HSS

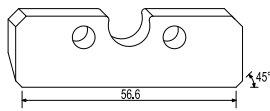

96009HSS

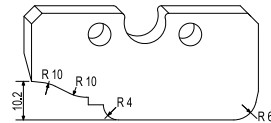

96010HSS

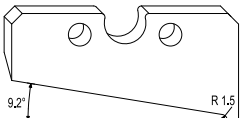

96011HSS

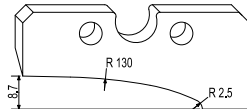

96014HSS

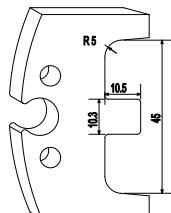

96015HSS

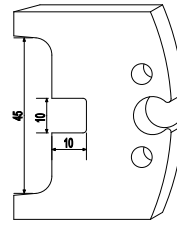

96017HSS

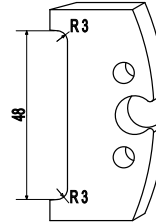

96018HSS

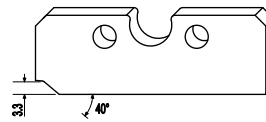

96019HSS

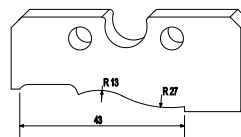

80 mm

98002HSS

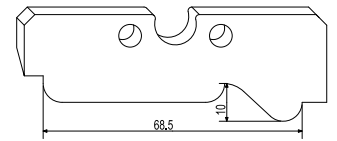

98003HSS

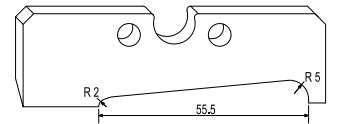

98004HSS

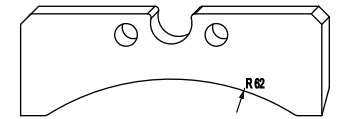

98005HSS

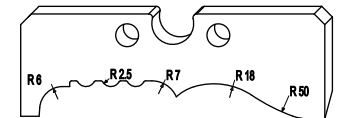

98006HSS

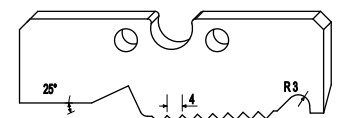

98008HSS

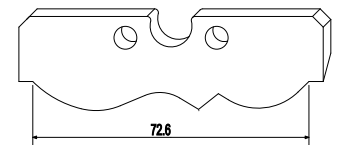

100 mm

91001HSS

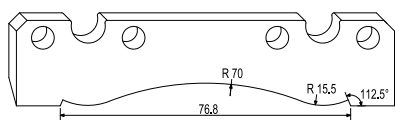

91002HSS

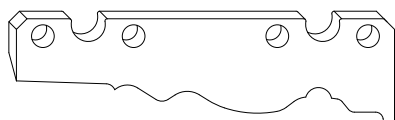

91003HSS

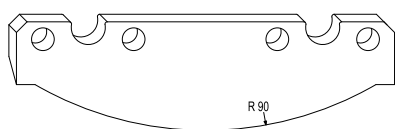

91004HSS

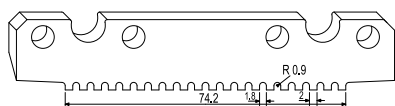

91010HSS Morapanel 95 mm

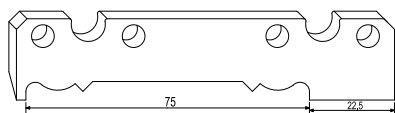

91012HSS Fasadpanel 95 mm

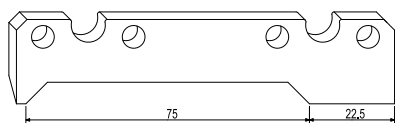

91014HSS Avrundad panel 95 mm

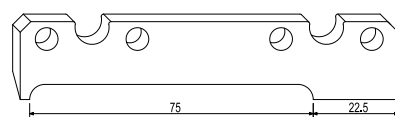

91016HSS Pärlspont 95 mm

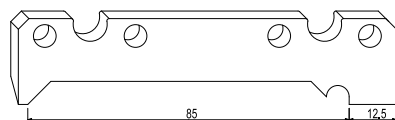

91018HSS Stockpanel 95 mm

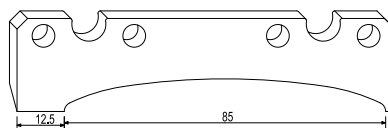

91020HSS

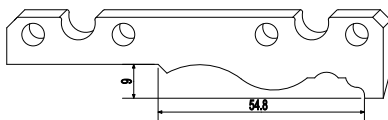

91021HSS

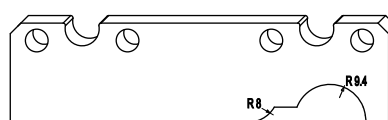

91022HSS

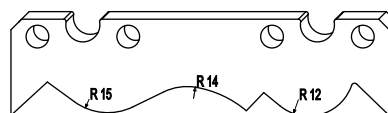

91023HSS

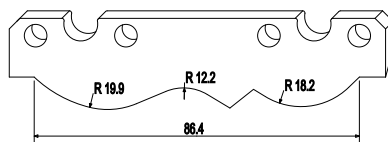

91025HSS

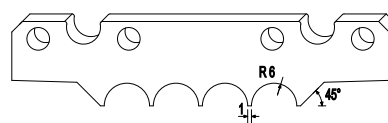

130 mm

■ 91301HSS Svanhalstaklist

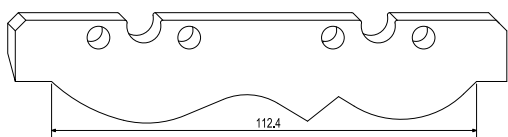

■ 91302HSS

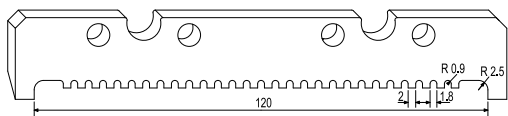

■ 91309HSS

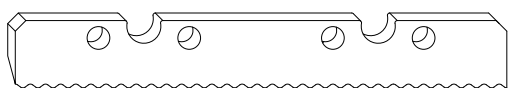

■ 91310HSS Morapanel 120 mm

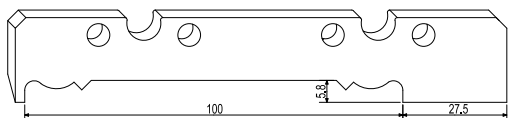

■ 91312HSS Faspanel 120 mm

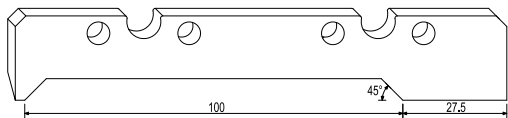

■ 91314HSS Avrundad panel 120 mm

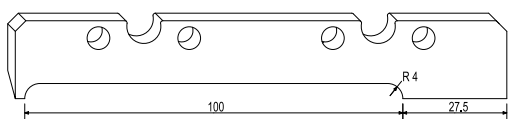

■ 91316HSS Pärlspont 120 mm

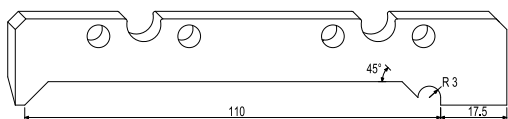

■ 91318HSS

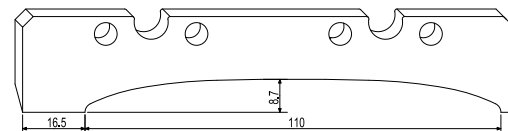

■ 91319HSS

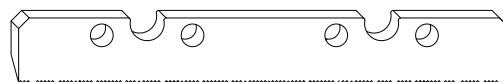

■ 91320HSS

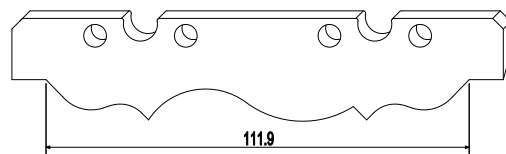

■ 91321HSS

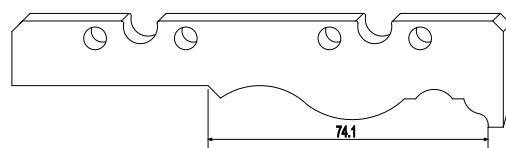

■ 91323HSS

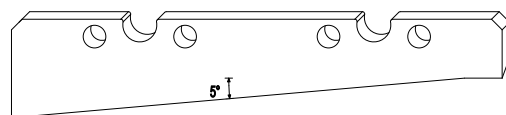

Fasta och ställbara fräsar till Logosolhyvlar

■ Fast fräs för ytterpanel.

Äntligen kan vi presentera en bra lösning för dig som producerar faspanel med ohyvlad utsida. Komplett set inklusive 2 st TB90 stål.

Art.nummer
7000-004-9030

Pris:
2020 kr/st

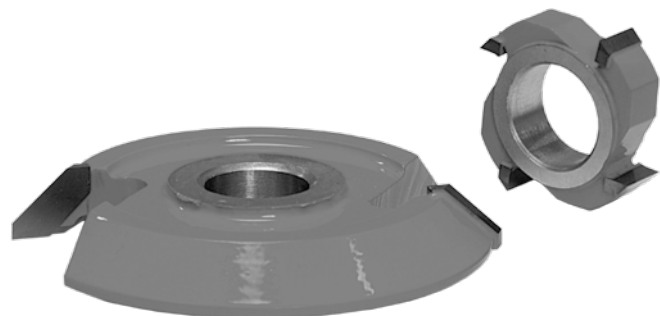

Dubbel faspanel

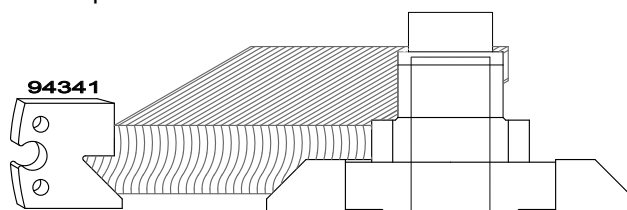

Enkel faspanel

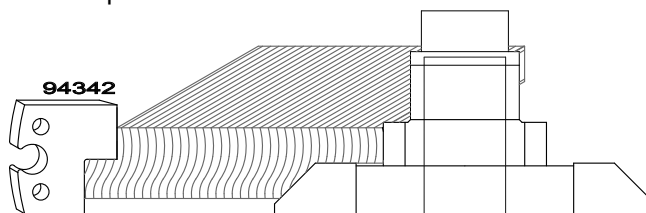

■ Fast notfräs HM

Råspont 6,4 mm

Art.nummer
WP51502

Pris:
1610 kr/st

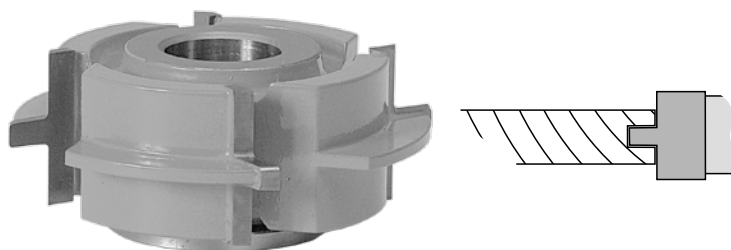

■ Fast spontfräs HM

Råspont 6,0 mm

Art.nummer
WP51501

Pris:
1260 kr/st

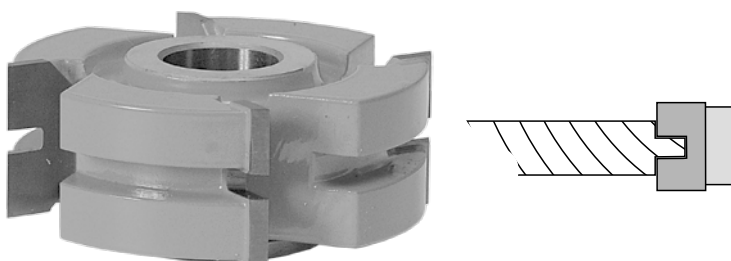

■ Ställbar regel- och trallfräs HM

Med fasad kant 45°. Fräset om 2 delar, ställbar i tjocklek mellan 19 mm och 50 mm med hjälp av medföljande mellanringar.

Art.nummer
WP51045

Pris:
2580 kr/st

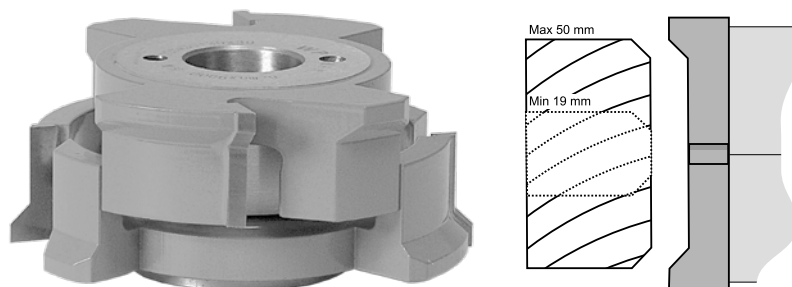

■ Ställbar regel- och trallfräs HM

Med rundad kant, radie 3 mm. Fräset om 2 delar, ställbar i tjocklek mellan 19 mm och 50 mm med hjälp av medföljande mellanringar.

Art.nummer
WP50903

Pris:
2580 kr/st

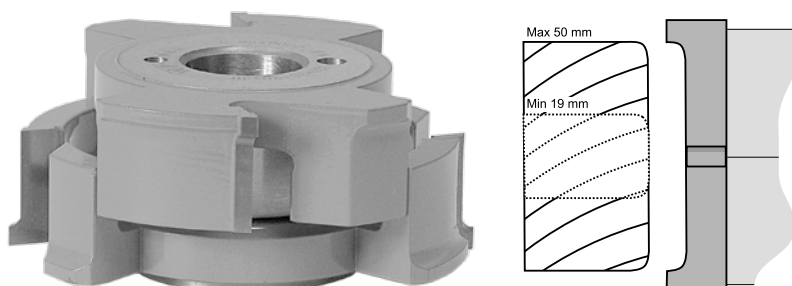



 **LOGOSOL**

www.logosol.se